



1 Instructions

1.1 General safety instructions

Risk of personal injury

- During use the appliance and its accessible parts become very hot.
- Never touch the heating elements during use.
- Keep children under eight years of age at a safe distance if they are not constantly supervised.
- Children must never play with the appliance.
- This appliance may be used by children aged at least 8 and by people of reduced physical, sensory or mental capacity, or lacking in experience in the use of electrical appliances, as long they are supervised or instructed by adults who are responsible for their safety.
- Never rest metallic objects such as knives, forks, spoons and lids on the appliance during use.
- Switch off the appliance immediately after use.
- Never try to put out a fire or flames with water: Turn off the appliance and smother the flames with a fire blanket or other appropriate cover.
- The appliance must never be cleaned by unsupervised children.
- Have qualified personnel carry out installation and assistance interventions according to the standards in force.

- Do not modify this appliance.
- Do not insert pointed metal objects (cutlery or utensils) into the slots in the appliance.
- Do not try to repair the appliance yourself or without the intervention of a qualified technician.
- Do not place plastic containers or inflammable objects in the drawer.
- If the power supply cable is damaged, contact technical support immediately and they will replace it.

Risk of damaging the appliance

- Do not use abrasive or corrosive detergents (e.g. scouring powders, stain removers or metallic scourers).
- Do not seat on the appliance.
- Do not use steam jets to clean the appliance.
- Do not obstruct ventilation openings and heat dispersal slots.
- Do not use the appliance to heat rooms for any reason.

For this appliance

- Do not rest any weight or sit on the open drawer.
- Take care that no objects are stuck in the drawer.



Instructions

1.2 Manufacturer liability

The manufacturer declines all liability for damage to persons or property caused by:

- Use of the appliance other than as envisaged;
- Non-observance of the user manual provisions;
- Tampering with any part of the appliance;
- Use of non-original spare parts.

1.3 Appliance purpose

- This appliance is intended for heating food and crockery in the home environment. Every other use is considered improper.
- This appliance may be used by children aged at least 8 and by people of reduced physical and mental capacity, or lacking in experience in the use of electrical appliances, provided that they are supervised or instructed by adults who are responsible for their safety.
- The appliance is not designed to operate with external timers or with remote-control systems.

1.4 Disposal



This appliance must be disposed of separately from other waste (Directives 2002/95/EC, 2002/96/EC, 2003/108/EC). The appliance does not contain substances in quantities sufficient to be considered hazardous to health and the environment, in accordance with current European directives.

To dispose of the appliance:

- Cut the power supply cable and remove it along with the plug.



Power voltage Danger of electrocution

- Disconnect the main power supply.
- Unplug the appliance.
- Deliver the appliance to the appropriate recycling centre for electrical and electronic equipment waste, or return it to the retailer when purchasing an equivalent product, on a one for one basis.



Our appliances are packed in non-polluting and recyclable materials.

- Deliver the packing materials to the appropriate recycling centre.



Plastic packaging Danger of suffocation

- Do not leave the packaging or any part of it unattended.
- Do not let children play with the packaging plastic bags.

1.5 Identification plate

The identification plate bears the technical data, serial number and brand name of the appliance. Do not remove the identification plate for any reason.

1.6 This user manual

We advise you to read this manual carefully, which contains all the instructions for maintaining the appliance's aesthetic and functional qualities.

This user manual is an integral part of the appliance and must therefore be kept in its entirety and within the user's reach for the whole working life of the appliance. For further information on the product: www.smeg.com
Read this user manual carefully before using the appliance.

1.7 How to read the user manual

This user manual uses the following reading conventions:



Instructions



General information on this user manual, on safety and final disposal.

Description



Description of the appliance and its accessories.

Use



Information on the use of the appliance and its accessories, cooking advice.

Cleaning and maintenance



Information for proper cleaning and maintenance of the appliance.

Installation



Information for the qualified technician: Installation, operation and inspection.



Safety instructions



Information



Advice

1. Use instruction sequence.
 - Standalone use instruction.



Description

2 Description

2.1 General Description

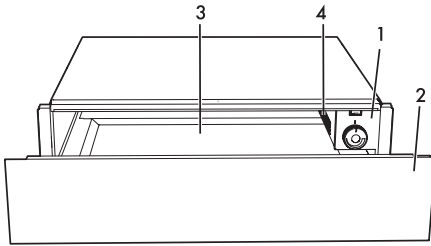

- 1 Control panel
- 2 Drawer
- 3 Non-slip base
- 4 Heating fan

2.2 Control panel

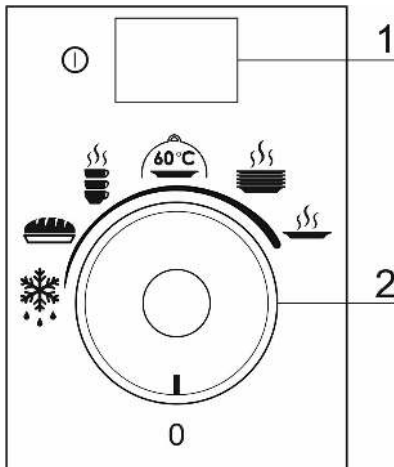

1 ON/OFF switch

Turns the appliance on and off.

2 Temperature knob

It allows you to select the required function.

2.3 Operating principles

The appliance is equipped with a hot-air ventilation system. A fan distributes the heat from the heating element inside the drawer in an optimal manner.

The temperature knob allows you to set and control the correct temperature for the crockery and food placed inside the appliance. The circulating hot air warms the crockery and food quickly and evenly.

A protective grille prevents accidental contact with the heating element and fan.

The base of the drawer is covered with non-slip material to stop dishes from moving when the drawer is opened or closed.

Capacity



Improper use
Risk of damages to the appliance

- Load the drawer with a maximum of 15 kg.



3 Use

3.1 Instructions



High temperature inside the drawer during use Danger of burns

- Keep the drawer closed during operation.
- Protect your hands with oven gloves when handling crockery and food in the drawer.
- Do not touch the heating elements inside the drawer.
- Do not allow children to approach the drawer when it is in use.



High temperature inside the drawer during use Danger of fire or explosion

- Do not spray any spray products near the drawer.
- Do not use or leave flammable materials near the drawer.
- Do not use plastic kitchenware or containers for heating food.
- Do not put sealed tins or containers in the drawer.

3.2 First use

1. Remove any protective film from the outside or inside of the appliance.
2. Remove any labels (apart from the identification label).
3. Clean the appliance using a damp cloth.
4. Dry the appliance thoroughly.
5. Heat the appliance for at least 2 hours, unloaded and at maximum temperature, to remove any manufacturing residue.

3.3 Using the drawer

Turning the drawer on and off

1. Press the ON/OFF switch.
2. Turn the temperature knob to any setting between minimum and maximum.

List of functions















Improper use Risk of damage to the appliance

- Before placing hot food in the drawer, wait for its temperature to fall below 80°C.



The heating time will vary depending on many different factors, for example the type and quantity of crockery inserted.

Function	Position of the temperature knob
Off	 0
Defrost	 
Proving	 
Cup warmer	 
Keep warm	 
Crockery warmer	 
Heat and reconstitute	 

* Preheat the drawer at maximum temperature for 5-10 minutes



Cleaning and maintenance

4 Cleaning and maintenance

4.1 Instructions



**Improper use
Risk of damage to surfaces**

- Do not use steam jets to clean the appliance.
- Do not use detergents which are abrasive, corrosive or which contain chlorine, ammonia or bleach (e.g. scouring powders, stain removers etc.).
- Do not use rough or abrasive materials or sharp metal scrapers.

4.2 Cleaning the appliance

Recommendations for cleaning the drawer

To keep the surfaces in good condition, they should be cleaned regularly after use. Let them cool first.

Avoid letting food residue dry inside the drawer, as this could damage the enamel.

Cleaning the drawer

1. Remove the non-slip base.
2. Place some non-abrasive detergent on a damp cloth and wipe down the surfaces.
3. Rinse thoroughly.
4. Dry with a soft cloth or a microfibre cloth.

Cleaning the non-slip base

1. Remove the non-slip base.
2. Clean it with warm water and non-

abrasive detergent. non abrasivo.

3. Dry thoroughly with a soft cloth or a microfibre cloth.
4. Replace the non-slip base in the drawer when perfectly dry.

4.3 What to do if...

Below we provide a list of possible solutions to some operating problems.



If the problem has not been resolved or in the event of other types of problem, contact Technical Support.

Crockery does not heat up:

- Check that the appliance is connected to the mains electricity supply.
- Check that the house's main circuit breaker is on.
- Check that the ventilation openings are not blocked.
- Check that it is possible to hear the noise of the fan, and contact Technical Support.
- Leave the crockery in the drawer for longer.

The drawer does not open:

- Grasp the lower part of the drawer and pull until it releases.

The main switch or main circuit breaker in the house's consumer unit are repeatedly triggered (or corresponding fuses blow):

- Call Technical Support or an electrician.



5 Installation

5.1 Electrical connection



Power voltage Danger of electrocution

- Have the electrical connection performed by authorised technical personnel.
- The appliance must be connected to ground in compliance with electrical system safety standards.
- Disconnect the main power supply.

General information

Check the grid characteristics against the data indicated on the plate.

The identification plate bearing the technical data, serial number and brand name is visibly positioned on the appliance.

Do not remove this plate for any reason.

The appliance works at 230 V~.

Use the power-supply cable provided with the appliance.

Fixed connection

Fit the power line with an omnipolar circuit breaker in compliance with installation regulations.

The circuit breaker should be located near the appliance and in an easily reachable position.

Connection with plug and socket

Make sure that the plug and socket are of the same type.

Avoid using adapters and shunts as these could cause overheating and a risk of burns.

5.2 Positioning



Heavy appliance Danger of crushing injuries

- Position the appliance into the cabinet cutout with the help of a second person.



Pressure on the open drawer Risk of damage to the appliance

- Never use the open drawer to lever the appliance into place when fitting.
- Avoid exerting too much pressure on the drawer when open.



Heat production during appliance operation Risk of fire

- Check that the piece of furniture material is heat resistant.
- Check that the piece of furniture has the required slots.



Installation

General instructions

- Position the drawer on a stable shelf.
- The supporting shelf must have a rear opening of 20 mm.
- The unit in which the drawer is installed must not have a back panel.

Installing the appliance

1. Centre and line up the drawer in the opening. Ensure that the frame is perfectly flush with the furniture unit.
2. Open the drawer.
3. Secure the appliance to the piece of furniture using screws.

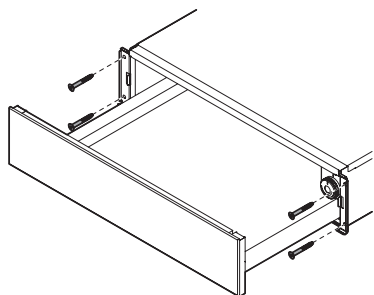

4. Position the side covers.

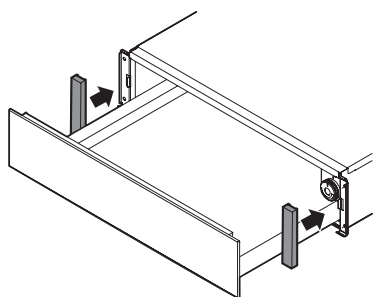

Appliance dimensions (mm)

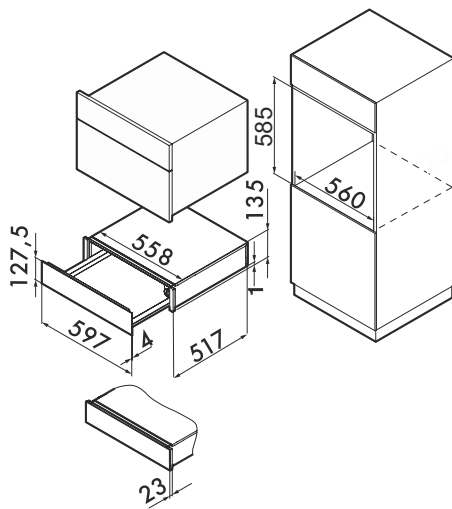
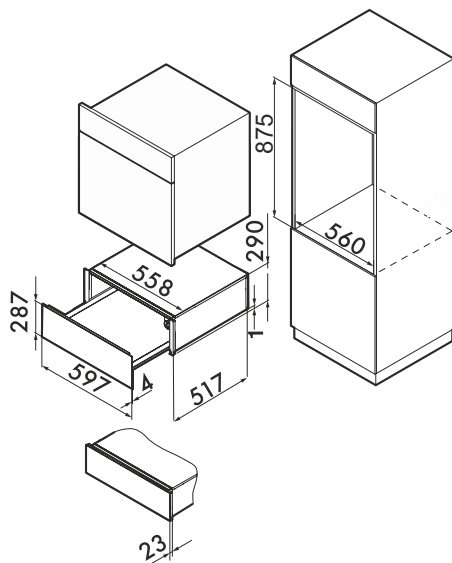

Follow the instructions provided in the relative use and installation booklet in order to install the appliance that can be combined with the drawer.