



Pando
integral**cooking**

PHT-941 PHT-963

ES - PT - FR - EN - DE

**Manual de uso
Certificado de Garantía**

**Manual de uso
Certificado de Garantía**

**Manuel d'utilisation
Certificat de garantie**

**User manual
Guarantee certificate**

**Benutzerhandbuchand
Garantiebescheinigung**



Certificación del Sistema de Gestión de la Calidad
Environmental Management System Certification
UNE-EN ISO 14001:2015
ES20/208675



Sistema de Gestión de la Calidad
Quality Management System
UNE-EN ISO 9001:2015
ES19/86566

www.pando.es

V22.1

En primer lugar queremos agradecerle la confianza depositada en nuestra firma por la adquisición de uno de nuestros productos. Estamos seguros que ha tomado la decisión más acertada.

En Pando, no solo ofrecemos productos de primera calidad, sino que disponemos de un amplio equipo de profesionales que le atenderán y asesorarán en cualquier consulta que se le presente a la hora de su instalación o funcionamiento.

También le invitamos a que visite nuestra página web (www.pando.es) para conocernos mejor y donde podrá ver toda nuestra gama de productos con la información comercial y técnica necesaria.

En ella encontrará una amplia selección de Campanas Decorativas de pared, de techo, de isla y de integración. Cuatro tipos de instalación que nos permiten adaptarnos a cualquier clase de cocina según las necesidades que se nos presenten.

También le mostramos nuestra colección de electrodomésticos imprescindibles en cualquier hogar. Electrodomésticos tales como nuestra colección de Hornos y Microondas con elevadas prestaciones, las Placas de Inducción y Gas que le ayudarán a realizar las mejores de las recetas, Vinotecas y bodegas de envejecimiento para mantener y conservar sus vinos en las mejores condiciones y Lavavajillas de integración con la tecnología más actual.

Todo ello bajo una Marca con una larguísima trayectoria de más de 40 años en el mercado, que elabora sus productos como un verdadero artesano. Plasmando en ellos lo mejor de nuestra experiencia para poder satisfacer todas sus necesidades.

Esperamos sinceramente que se divierta, experimente y disfrute del confort y capacidades del que ya es su nuevo aliado en la cocina.

Muchas gracias

El equipo de Pando

1. DESCRIPCIÓN DEL HORNO	5
2. FRONTAL DE MANDOS	5
3. ENCENDIDO Y PUESTA EN HORA	6
4. DESCRIPCIÓN DE LA PANTALLA DE CONTROL	7
4.1. Pantalla de inicio / reposo.....	7
4.2. Pantalla de seleccion.....	8
4.3. Pantalla de cocinado.....	9
5. COCINADO CON FUNCIONES TRADICIONALES	10
5.1. Funciones del horno.....	10
5.2. Para cocinar con las funciones tradicionales.....	11
5.3. Precalentamiento rápido automático.....	11
6. COCINADO CON EL ASISTENTE PERSONAL DE COCINADO (PANDO CHEF)	12
6.1. Recetas automáticas del horno.....	12
6.2. Receta para cocinar con el asistente personal de cocinado.....	13
6.3. Precalentamiento en vacío.....	14
6.4. Volteo del alimento.....	14
7. PROGRAMACIÓN TEMPORIZADA DEL HORNO	15
7.1. OPCIONES DE TEMPORIZACIÓN.....	15
7.2. PARA PROGRAMAR LAS OPCIONES DE TEMPORIZACIÓN.....	16
8. FUNCIONES DE SEGURIDAD	17
8.1. Bloqueo de seguridad para niños (bloqueo del panel de control).....	17
9. FUNCIÓN SCS (Steam Clean System by PANDO)	18
10. MODO DEMO (Función especial para exposiciones)	20
11. ESPECIFICACIONES TÉCNICAS	21
12. ESQUEMAS INSTALACIÓN Y COTAS	22
13. CERTIFICADO DE GARANTÍA PANDO	24

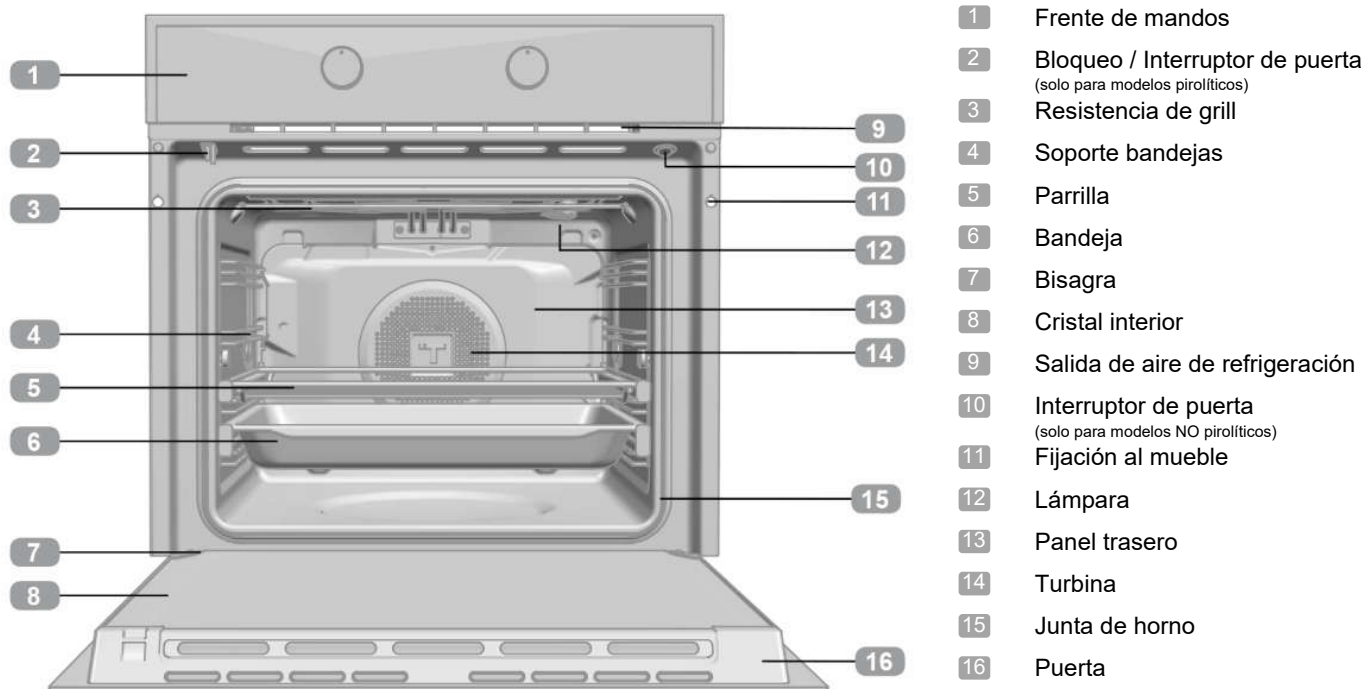
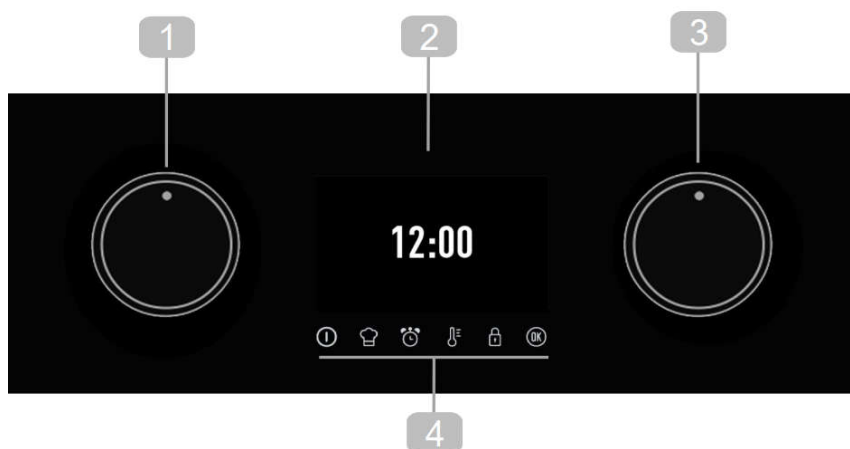
1. DESCRIPCIÓN DEL HORNO**2. FRONTAL DE MANDOS**

- 1 Mando para desplazarse por los menús de la parte izquierda de la pantalla. Selector de modos de cocinado.
- 2 Pantalla de visualización.
- 3 Mando para desplazarse por los menús de la parte derecha de la pantalla. Selector de ajustes de cocinado.
- 4 Teclas.

① Encendido / apagado del horno.

🌡️ Modificación de temperatura del horno.

👨‍🍳 Acceso al asistente personal de cocinado (PANDO CHEF)

🔒 Activación / Desactivación del bloqueo del teclado / puerta según modelos.

🕒 Acceso a las funciones de temporización y programación del horno.



OK Tecla de validación.
Apagado / Encendido de la luz interior.

3. ENCENDIDO Y PUESTA EN HORA

Al conectar el horno por primera vez a la red, aparecerá el logotipo seguido de la indicación 12:00 parpadeando.

Para poder trabajar con el horno, es necesario poner en hora el reloj.

ESTABLECIMIENTO DE LA HORA:

- Seleccione las horas con el mando izquierdo y los minutos con el mando derecho. Valide la selección con la tecla  o espere unos segundos.
- Seleccione con el mando derecho el tipo de grafismo para la visualización de la hora. Confirme la selección con la tecla  o espere unos segundos.

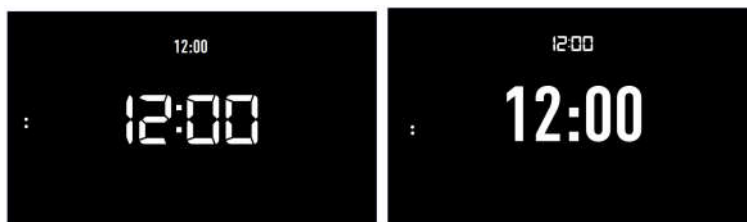

Escuchará una señal acústica como confirmación, y la hora quedará fijada en la pantalla.

Para modificar la hora:

Con el horno en reposo (pantalla de inicio), mantenga presionada la tecla  hasta que la hora aparezca parpadeando. Siga los pasos descritos anteriormente para modificar la hora.



ATENCIÓN

La sensibilidad de las teclas touch se adapta continuamente a las condiciones ambientales. Al conectar el horno a la red tenga la precaución de que la superficie de cristal del frontal de mandos esté limpia y libre de cualquier obstáculo.

Si al tocar el cristal, la pantalla no responde correctamente, entonces es necesario que desconecte el horno de la red eléctrica y tras un instante vuelva a conectarlo. De esta forma los sensores se habrán ajustado automáticamente y reaccionarán de nuevo al tocar con el dedo.



ATENCIÓN

En caso de un corte de suministro eléctrico, se borrará toda la programación de su reloj electrónico.

Aparecerá la indicación 12:00.

Puede poner el reloj en hora siguiendo las instrucciones anteriores.

Si el horno tenía la puerta bloqueada antes del corte de suministro, el símbolo de bloqueo se iluminará hasta que la puerta se desbloquee.

Esto puede llevar varios minutos, dependiendo de la temperatura a la que se encuentra el horno, y durante este tiempo no podrá poner el reloj en hora.

Una vez desbloqueada la puerta, puede poner el reloj en hora siguiendo las instrucciones anteriores.

4. DESCRIPCIÓN DE LA PANTALLA DE CONTROL

A continuación se describe la información que encontrará en la pantalla de visualización de su horno y cómo esta se mostrará.

4.1. PANTALLA DE INICIO / REPOSO

Esta pantalla aparecerá cuando el horno no esté funcionando, pero esté conectado a la red.

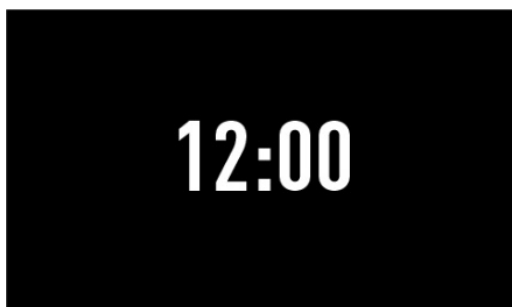

Si el bloqueo de teclado está activado, el símbolo  aparecerá en la parte superior.

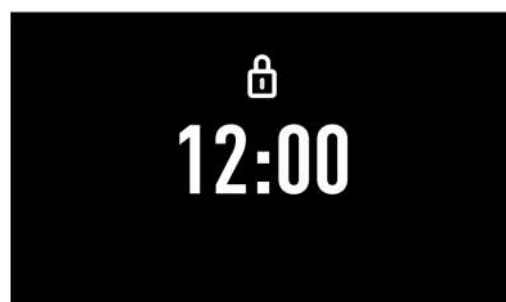

Si ha programado un aviso, la pantalla dejará de mostrar la hora, y mostrará la cuenta atrás, como se indica en la imagen siguiente.

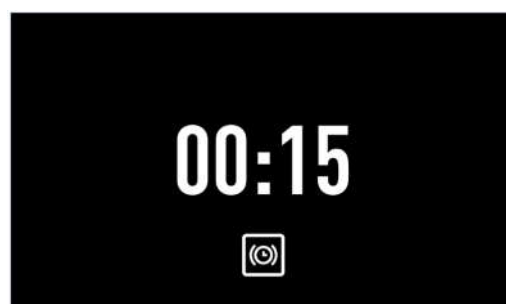

4.2. PANTALLA DE SELECCION

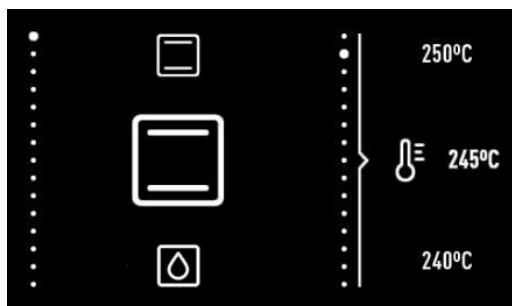

SELECCIÓN DE FUNCIÓN:

- Poner en marcha la unidad mediante el botón de encendido ①

Durante la selección de una función de cocinado, receta automática o función de reloj, la pantalla aparecerá dividida en dos sectores:

SECTOR IZQUIERDO.

En esta zona de la pantalla se muestran las funciones de cocinado, recetas automáticas o funciones de programación del reloj disponibles para su selección.

Para seleccionar cualquiera de ellas, gire el mando izquierdo hasta que la función deseada aparezca aumentada y valide la selección con la tecla **OK** (si usted no toca ninguna tecla, pasados unos segundos el horno validará la selección automáticamente).

SECTOR DERECHO.

En esta zona de la pantalla, se muestran los valores a ajustar en función del modo seleccionado: temperatura, peso, duración, hora de finalización...

Para seleccionar un valor, gire el mando derecho hasta elegir el valor deseado y valide la selección con la tecla **OK** (si usted no toca ninguna tecla, pasados unos segundos el horno validará la selección automáticamente).

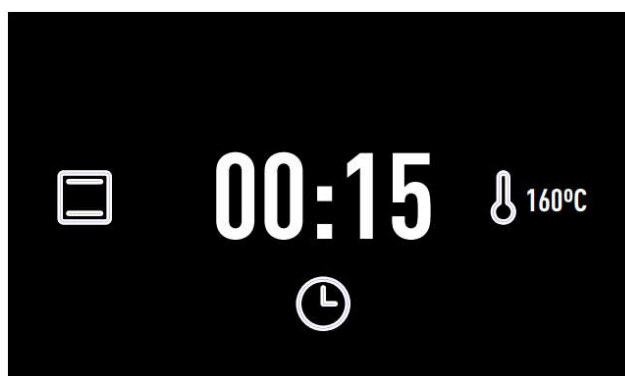
4.3. PANTALLA DE COCINADO

Durante el cocinado, la información sobre la situación del horno aparecerá en la pantalla organizada alrededor de dígitos centrales, en color blanco, que irán marcando el tiempo:

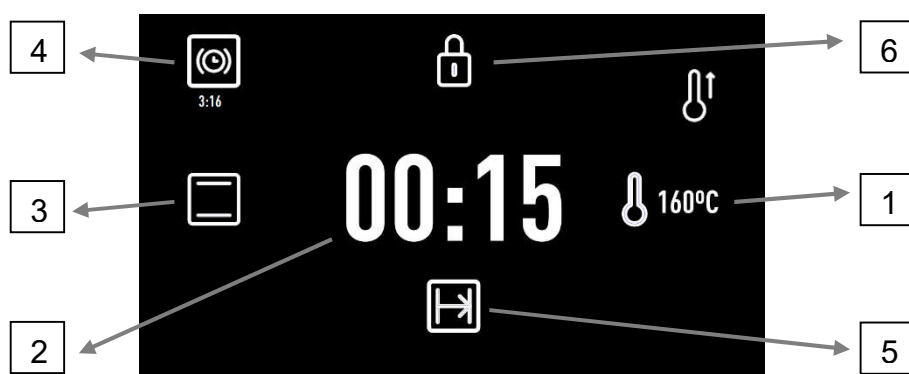
**1. Temperatura seleccionada.**

El símbolo  parpadeará en rojo hasta que se alcance la temperatura seleccionada y siempre que el horno esté transmitiendo calor al alimento. Al alcanzar la temperatura seleccionada, este símbolo se apagará permaneciendo solo el indicador azul.

2. Duración del cocinado.

Si no ha programado el reloj, se mostrará el tiempo que el horno lleva cocinando.

Si ha realizado alguna programación, mostrará el tiempo que falta para que el cocinado termine (cuenta atrás).

Si el horno está programado, pero en situación de espera (no ha empezado a cocinar), se mostrará la duración total de cocinado programada.

3. Función de cocinado o receta automática seleccionada.

Si ha programado funciones de tiempo, la información relativa a estas funciones se muestra en la pantalla.

4.  **Avisador:** Cuenta atrás para la finalización del aviso programado.

5.  **Hora de Finalización**

Si ha activado funciones de seguridad, la información relativa a esta función se muestra en la pantalla.

6.  **Bloqueo de teclado.** Se iluminará cuando esté activado el bloqueo de seguridad de niños.

5. COCINADO CON FUNCIONES TRADICIONALES**5.1. FUNCIONES DEL HORNO****INFORMACIÓN**

Para una descripción de uso de cada una de las funciones, consulte la guía de cocinados incluida en su horno.

**DESCONEXIÓN****CONVENCIONAL** **CONVENCIONAL CON TURBINA** **GRILLY SOLERA** **MAXIGRILL****GRILL****SOLERA** **PIZZA** **TURBO** **A FUEGO LENTO****FERMENTAR MASAS****DESCONGELACIÓN****ECO****SCS (Steam Cleaning System by PANDO)****Funciones que incorporan precalentamiento rápido automático**

5.2. PARA COCINAR CON LAS FUNCIONES TRADICIONALES

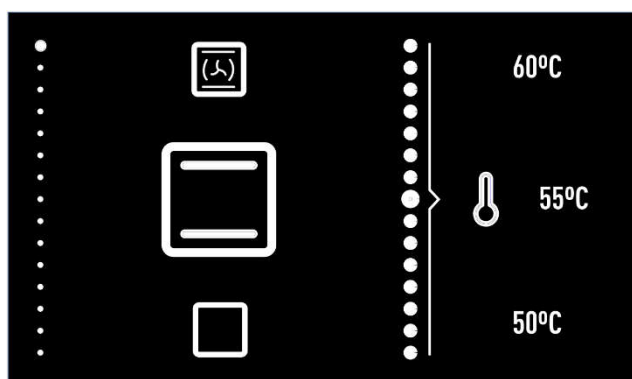

Selección de función.

Encienda el horno tocando la tecla

Gire el mando izquierdo hasta que la función deseada aparezca aumentada.

A continuación, aparecerá a la derecha la temperatura recomendada para la función elegida.

Si lo desea, puede modificar la temperatura girando el mando derecho.

Valide la selección con la tecla

En cualquier momento del cocinado usted puede:

- **Cambiar la función de cocinado**, girando el mando izquierdo.
- **Modificar la temperatura de cocinado** girando el mando derecho.
- **Programar un aviso o una duración / hora fin de cocinado**. Tocando la tecla
- **Modificar la programación de avisos o duración / hora fin programados**. Tocando la tecla



INFORMACIÓN

Para programar o modificar una programación, consulte el apartado «Programación temporizada del cocinado» que encontrará más adelante en esta guía de uso.

































5.3. PRECALENTAMIENTO RÁPIDO AUTOMÁTICO

Las funciones señaladas, incorporan precalentamiento rápido automático.

Durante el precalentamiento rápido, se ilumina el símbolo .

Se recomienda no introducir el alimento hasta que este símbolo se apague.

6. COCINADO CON EL ASISTENTE PERSONAL DE COCINADO (PANDO)**6.1. RECETAS AUTOMÁTICAS DEL HORNO**

AVES			POLLO		
			PATO		
			GANSO		
			PAVO		
CARNES			COCHINILLO		
			BUEY		
			CORDERO		
			CHULETAS		
PESCADOS			MERLUZA		
			SALMÓN		
PANES			PAN BLANCO		
			PAN MORENO		
			PAN INTEGRAL		
PIZZAS			PIZZA GRUESA		
			PIZZA FINA		
POSTRES			PASTEL DE MOLDE		
			PASTEL DE FRUTAS GRANDE		
			PASTEL DE FRUTAS PEQUEÑO		
			PASTEL EN BANDEJA		

 Recetas que requieren precalentar el horno en vacío.

 Recetas que requieren dar la vuelta al alimento.

6.2. RECETA PARA COCINAR CON EL ASISTENTE PERSONAL DE COCINADO

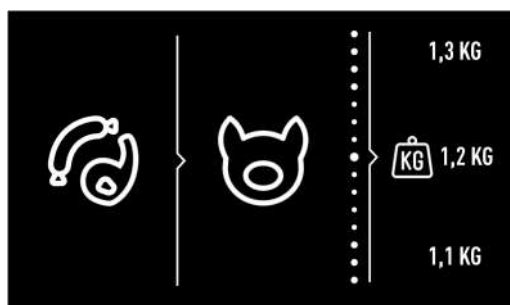

Selección de receta.

Gire el mando izquierdo hasta que el tipo de alimento que desea cocinar aparezca aumentado. En el sector derecho de la pantalla, se mostrarán a continuación las recetas disponibles para el tipo de alimento seleccionado. Seleccione con el mando derecho la receta deseada y valide la selección con la tecla **OK**.

En el sector derecho de la pantalla, aparecerá a continuación la información que el horno necesita para programar el cocinado.

Según la receta seleccionada, el horno le pedirá que introduzca:

PESO DEL ALIMENTO: Seleccione con el mando derecho y valide con la tecla **OK**.

TEMPERATURA: Valde la temperatura propuesta por la receta o seleccione otra con el mando derecho y valide con la tecla **OK**.

GRADO DE ACABADO: En algunos cocinados, usted puede seleccionar el grado de acabado:

- **HIGH:** Acabado muy hecho
- **MEDIUM:** Acabado al punto
- **LOW:** Acabado poco hecho

Una vez seleccionados todos los parámetros, valide con la tecla **OK**.

El horno empezará a cocinar, y la pantalla de selección dará paso a la pantalla de cocinado, en la que se mostrará la siguiente información:

- Temperatura de cocinado seleccionada
- Tiempo restante de cocinado
- Receta seleccionada

Una vez finalizado el cocinado, sonará una alarma acústica durante 90 segundos aproximadamente y en la pantalla parpadeará el símbolo del cocinado. Toque cualquier tecla para detener el sonido.

El horno se apagará automáticamente.



INFORMACIÓN

Durante los primeros 10 minutos del cocinado, usted podrá modificar el peso y el grado de acabado, o programar una hora de finalización del cocinado.

Pasado este tiempo, estos valores quedan fijados y no podrán modificarse.

Para modificar estos valores del cocinado, toque la tecla **OK** y el horno volverá a la pantalla de selección.

En cualquier momento del cocinado usted puede:

Modificar la temperatura de cocinado, tocando sobre la tecla **OK**. Valde con la tecla **OK**.

Programar un aviso. Tocando la tecla **OK**.

Modificar la programación de un aviso programado. Tocando la tecla **OK**.

Para programar, o modificar una programación, siga las instrucciones del apartado «Programación temporizada del cocinado» que encontrará más adelante en esta guía de uso

6.3. PRECALENTAMIENTO EN VACÍO

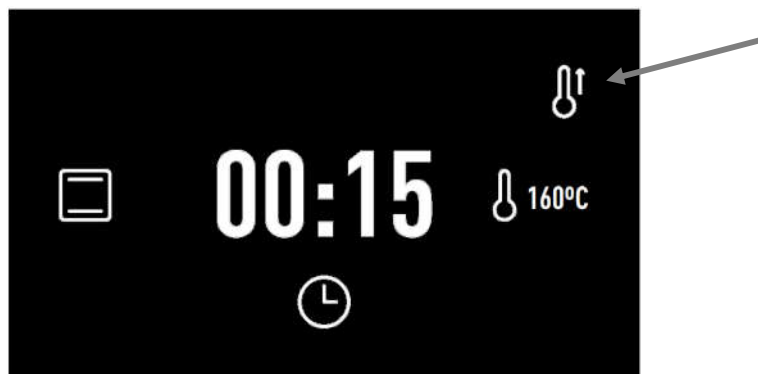



Las recetas indicadas en la tabla con el símbolo  , requieren introducir el alimento con el horno ya caliente.

Cuando seleccione una de estas recetas, al iniciar el cocinado se mostrará el símbolo  en la pantalla. Cuando el horno alcance la temperatura de cocinado, el símbolo parpadeará y sonará una alarma para avisar de que ya puede introducir el alimento.

La alarma se apaga automáticamente al abrir la puerta del horno para introducir el alimento, y en la pantalla de cocinado se mostrará el tiempo restante.

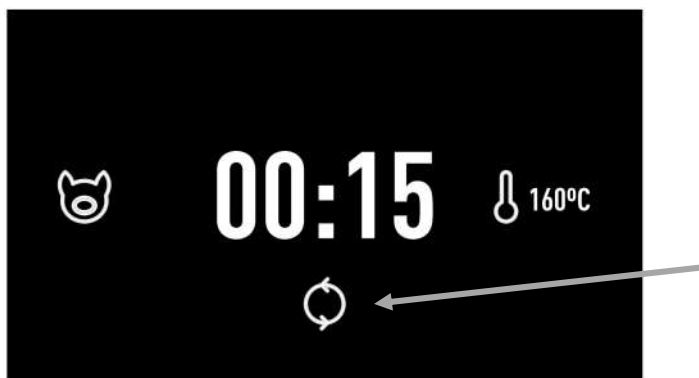
6.4. VOLTEO DEL ALIMENTO



Las recetas indicadas en la tabla con el símbolo  , requieren dar la vuelta al alimento durante el cocinado.

El horno le avisará cuándo debe hacerlo con una alarma sonora y en la pantalla de cocinado se mostrará el símbolo .

La alarma se apaga automáticamente al abrir la puerta del horno para dar la vuelta al alimento.

7. PROGRAMACIÓN TEMPORIZADA DEL HORNO

7.1. OPCIONES DE TEMPORIZACIÓN

Usted dispone de las siguientes opciones de temporización para programar un cocinado:

 **Avisador:** Genera una alarma que sonará al terminar el tiempo programado. El cocinado, NO se detendrá cuando acabe el tiempo. También puede generar un aviso cuando el horno no está cocinando.

INFORMACIÓN

Usted puede programar un Aviso, en cualquier momento, independientemente de que el horno esté cocinando o no.

El resto de opciones de temporización, estarán disponibles sólo cuando el horno esté cocinando.

 **Duración del Cocinado:** Permite seleccionar el tiempo que el horno estará cocinando.



Al finalizar el tiempo programada sonará una alarma, el símbolo  parpadeará y el horno dejará de calentar de forma automática.

Toque cualquier tecla para detener la alarma y apagar el horno.

 **Hora de Finalización del Cocinado:** Permite seleccionar la hora hasta la que el horno estará cocinando.

Cuando llegue la hora programada sonará una alarma, el símbolo  parpadeará y el horno dejará de calentar de forma automática.

Toque cualquier tecla para detener la alarma y apagar el horno.

- **Comienzo de cocinado diferido ( Duración +  hora de Finalización del Cocinado):** Permite programar el horno para que empiece el cocinado de forma automática y se apague también de forma automática una vez transcurrido el tiempo de cocinado programado.

INFORMACIÓN

Para programar esta opción, deberá programar la Duración y la Hora de Finalización del Cocinado consecutivamente.

Usted podrá acceder a las opciones de programación en cualquier momento de un cocinado.

De la misma forma, podrá acceder a modificar una programación ya establecida.

10 segundos antes de comenzar la temporización programada, se oirá un beep sonoro que puede cancelar pulsando cualquier botón.

Al acabar la programación, se vuelve a oír el beep sonoro que puede cancelar pulsando cualquier botón.

Si no pulsase ningún botón, la beep sonoro deja de oírse a los 2 minutos.

INFORMACIÓN

Si usted ha seleccionado una receta automática, el horno determinará automáticamente la Duración del cocinado, por lo que esta opción no estará disponible.

En este caso sí que podrá:

Programar la Hora de Finalización durante los diez primeros minutos del cocinado.

Programar un aviso en cualquier momento.

7.2. PARA PROGRAMAR LAS OPCIONES DE TEMPORIZACIÓN

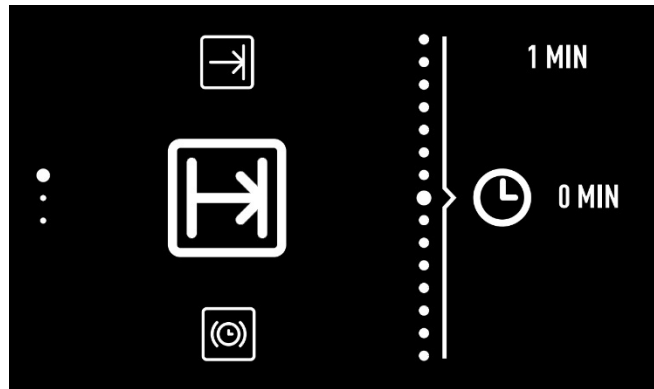

Programación duración del cocinado.

1. Toque sobre la tecla  para acceder al menú de opciones de temporización.
2. Gire el mando izquierdo para seleccionar la opción de programación deseada.
3. Gire el mando derecho para seleccionar la duración o la hora de finalización según la opción elegida.



INFORMACIÓN

El horno no permitirá seleccionar una hora de finalización anterior a la hora actual. Cuando esté programando una hora de finalización, se mostrará en la zona central la hora actual para facilitar la selección.



4. Valide la selección con la tecla .
5. A continuación volverá a mostrarse la pantalla de cocinado. Podrá ver las temporizaciones programadas a la derecha del círculo central.



8. FUNCIONES DE SEGURIDAD

8.1. BLOQUEO DE SEGURIDAD PARA NIÑOS (BLOQUEO DEL PANEL DE CONTROL)

Esta función se puede activar en cualquier momento:

- **Con el horno apagado.** El bloqueo de niños no permitirá que el horno se encienda al pulsar la tecla .
- **Durante el uso del horno.** Si activa la función mientras el horno está cocinando o en espera, se bloqueará la respuesta del teclado y los mandos y ningún valor de cocinado podrá modificarse.

Para activar la función, toque la tecla  de forma prolongada hasta que escuche 1 beep sonoro y el símbolo  aparezca en la pantalla. El panel de control está bloqueado.

Para desactivar la función, toque de nuevo la tecla  de forma prolongada hasta que escuche 1 beep sonoro y el símbolo  desaparezca.

9. FUNCIÓN SCS (Steam Clean System by PANDO)

Esta función facilita la limpieza de la grasa y los restos de suciedad que han quedado adheridos en las paredes del horno.

Para una mayor facilidad de limpieza, evite que se acumule la suciedad. Limpie el horno con frecuencia.

PROGRAMAR LA FUNCIÓN SCS

ATENCIÓN

No vierta agua en el interior del horno caliente, puede dañar el esmalte de su horno.

Realice siempre el ciclo con el horno frío. Si lo hace con el horno demasiado caliente, el resultado puede verse afectado además de dañar el esmalte.

Retire previamente las bandejas y todos los accesorios del interior del horno, incluidos los soportes para bandejas o guías telescópicas.

Siga para ello las siguientes instrucciones:

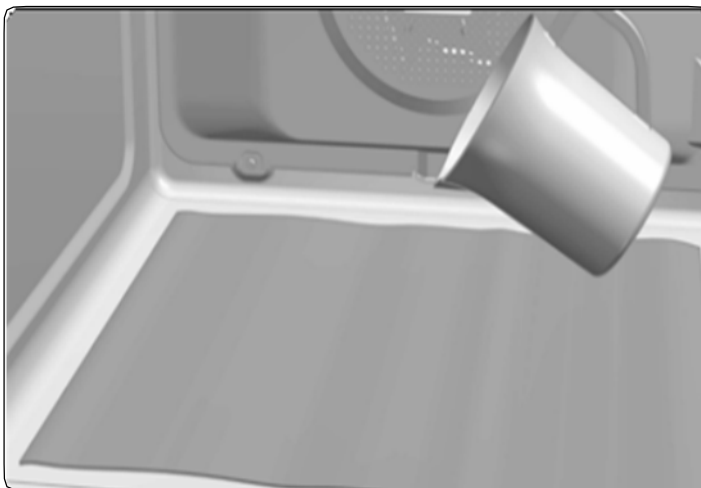

1. Con el horno frío, coloque una bayeta extendida sobre el suelo del horno.



2. Vierta lentamente 200 ml de agua en la parte inferior de la cavidad del horno.

INFORMACIÓN

Para un mejor resultado añada una cucharadita de detergente suave para vajilla en el vaso de agua antes de verterlo sobre la bayeta.

3. Encienda el horno, gire el mando izquierdo para seleccionar la función  y valide con .
4. A continuación se oirá una señal sonora como confirmación de que la función SCS se ha puesto en marcha.

En la pantalla se visualizará el símbolo  y el tiempo restante para que finalice la función .

El tiempo de duración está preestablecido a 24 minutos.

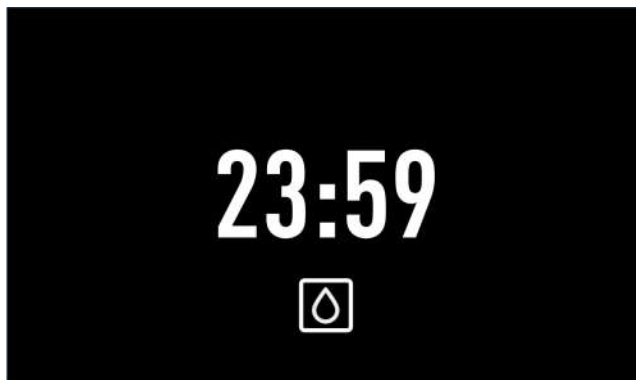

IMPORTANTE

La duración de esta función no se puede modificar. Para finalizar antes de tiempo, apague el horno con la tecla .

5. Alcanzada la hora de finalización, el horno se desconectará, sonará una señal acústica y el símbolo  parpadeará rápidamente.



IMPORTANTE

No abra la puerta del horno hasta que no finalice la función SCS.

La fase de enfriamiento es necesaria para el correcto funcionamiento de la función.

6. Pulse cualquier tecla para detener la señal acústica y apagar el símbolo .

7. El horno se apagará automáticamente.

8. El horno está listo para retirar los restos de suciedad y agua sobrante con la bayeta.

La función SCS se realiza a baja temperatura. No obstante, los tiempos de enfriamiento pueden variar según la temperatura ambiente.



ATENCIÓN

Asegúrese antes de tocar directamente la superficie interior del horno, de que la temperatura es adecuada.



Si tras realizar la función SCS requiere de una limpieza con más profundidad, utilice detergentes neutros y esponjas no abrasivas.

10. MODO DEMO (Función especial para exposiciones)

Con el modo DEMO activado, puede manejarse el horno sin calentar.

Se recomienda activar este modo si el horno va a instalarse en una exposición con conexión a red.

Activación del modo DEMO

Antes de poner el reloj en hora, pulsar simultáneamente las teclas  y , hasta que en la pantalla aparezca la indicación «DEMO Mode ON».

A continuación, ponga el horno en hora.

La palabra «DEMO» aparecerá permanente- mente en la pantalla y el horno puede operarse normalmente, pero no calentará.

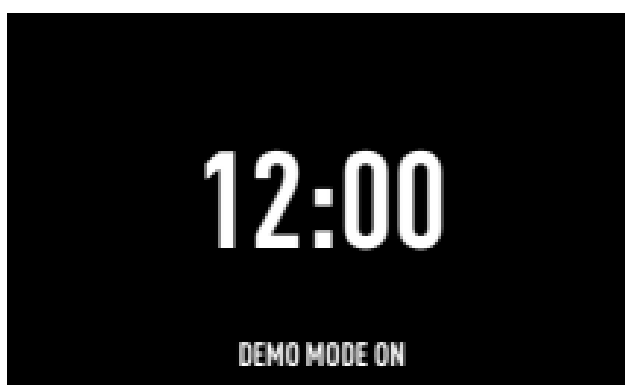

Para desactivar el modo DEMO, debe desconectar el horno de red.

11. ESPECIFICACIONES TÉCNICAS

INSTALACIÓN	PHT-941	PHT-963
Tensión (V)	220-240	220-240
Frecuencia (Hz)	50/60	50/60
Cable de Alimentación (m)	1,1 m WITHOUT PLUG	1,1 m WITHOUT PLUG
Dimensiones de Encastre (Alto x Ancho x Fondo) (mm)	450-460 x 560-568 x 580	590-600 x 560-568 x 580
Dimensiones producto sin panel frontal (Alto x Ancho x Fondo) (mm)	430x545x537	570x545x537
LOGÍSTICA / EMBALAJE		
Peso Neto (Kg)	25	32
Peso Bruto (Horno+Emb) (Kg)	27	34
Dimensiones Embalaje (Alto x Ancho x Fondo) (mm)	510x635x655	650x635x655
ACCESORIOS		
Manual de Instrucciones - Idiomas (2)	ES/PT/UK/FR/GE	ES/PT/UK/FR/GE
Bandeja Plana 30	1	1
Bandeja Profunda 50	1	1
Parrilla Reforzada	1	1
PRESTACIONES		
Volumen Útil (1) (L)	44	70
Volumen Interior Global (1) (L)	45	71
Superficie de Cocinado Útil (1) (cm ²)	1280	1280
Rango de Temperaturas	30-270 °C	30-270 °C
VALORES DE POTENCIA ELÉCTRICA		
RESISTENCIAS		
Grill + Bóveda	1.400 W +1.100 W	1.400 W +1.100 W
Solera	1.150 W	1.150 W
Circular	1800	2000
Motor Turbo	22	22
Motor Refrigeración	18 W	18 W
Potencia Iluminación	25 W	25 W
ILUMINACIÓN		
LUZ INERIOR	HALOGEN	HALOGEN
FUNCIÓN DE POTENCIA MÁXIMA		
	Bottom + TURBO (Pizza)	Bottom + TURBO (Pizza)
Potencia Máxima Horno (230 V)	3015 W	3215 W
CONSUMO ENERGÉTICO (1) (3) - PRODUCT FICHE		
Función más Eficiente	ECO	ECO
Índice de Eficiencia Energética (EEI)	80,8	81
Clase de Eficiencia Energética	A+	A+
MARCAS Y CERTIFICADOS	CE / N / CCA / CB / EAC / G - Mark	CE / N / CCA / CB / G - Mark

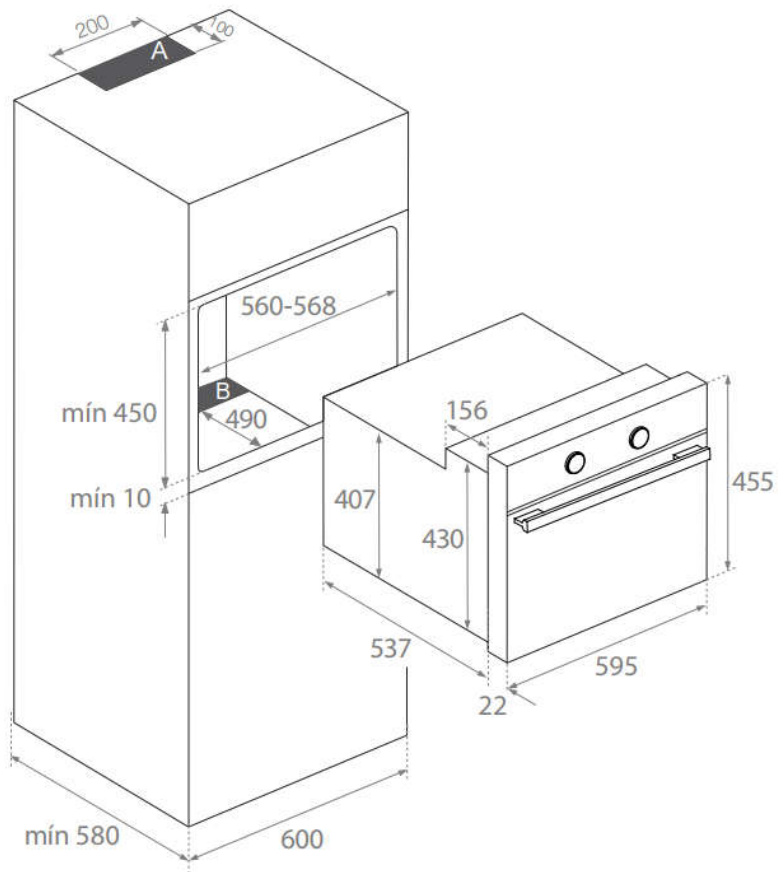
12. ESQUEMAS INSTALACIÓN Y COTAS**PHT 941****INSTALACIÓN EN COLUMNA****⚠ AVISO**

Respetar los huecos de ventilación en el mueble, ver dibujos instalación (200x100mm en zona **A** y 560x90mm en zona **B**). De no disponer de estas ventilaciones el producto no funcionará correctamente y podría sufrir daños que **NO** estarían cubiertos por la garantía.

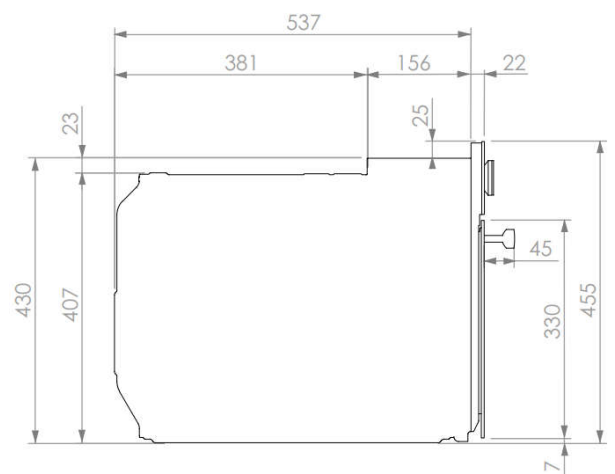
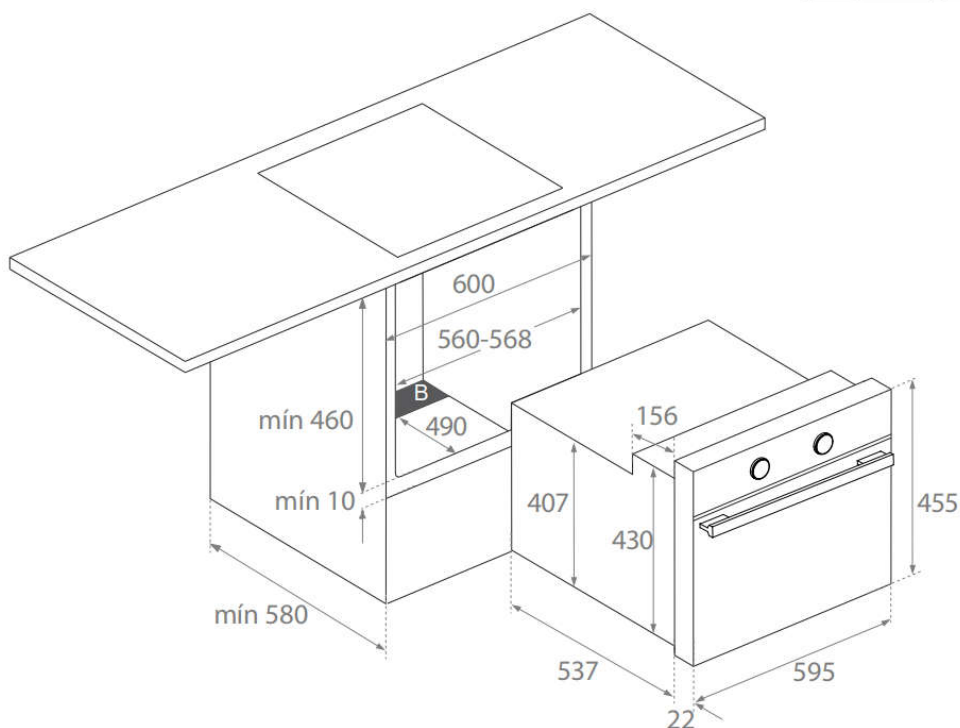
**INSTALACIÓN BAJO ENCIMERA**

13. CERTIFICADO DE GARANTÍA PANDO

INOXPAN S.L., le agradece la elección y confianza depositada en un producto de nuestra marca Pando, que se distingue por su Calidad, Diseño e Innovación, siendo fiel a sus orígenes y compromisos.

CONDICIONES GARANTIA PANDO:

Este aparato dispone de una garantía de 3 años a partir de la fecha de compra y cubre a este contra todo defecto de fabricación que afecte a su buen funcionamiento. Para la validez de la misma es imprescindible presentar la factura o ticket de compra ante el técnico del Servicio Oficial Autorizado Pando.

Durante dicho periodo, la Empresa se compromete a reponer o reparar gratuitamente cualquier pieza defectuosa debida a vicio o defecto de fabricación del aparato, hasta conseguir su funcionamiento correcto, así como la mano de obra necesaria y gastos ocasionados como consecuencia de tal reparación o reposición.

EXCLUSIONES DE LA GARANTÍA PANDO:

No estará cubierto por la garantía o podría ser causa de anulación de la misma, debiéndose hacer cargo en estos casos el usuario de las costas de los materiales, mano de obra y desplazamiento del servicio técnico, **los siguientes supuestos:**

- Revisiones de instalación o funcionamiento, limpiezas o mantenimientos.
- Averías o desperfectos ocasionados por no respetar o seguir las instrucciones de seguridad, recomendaciones de uso y mantenimiento de los manuales del aparato.
- Si la instalación del aparato no ha sido efectuado por personal Profesional Especialista Autorizado o personal de Servicio Técnico Oficial Pando, que cumplan los requisitos de los estándares de seguridad y normativa de potencia eléctrica.
- Cuando el aparato se destine a uso comercial o No doméstico, para el que no está previsto.
- Mal funcionamiento del producto por incumplimiento de las normas, instrucciones y recomendaciones indicadas en los manuales del aparato.
- Averías o problemas producidos por una inadecuada instalación, o por no disponer en el mobiliario de los espacios libres requeridos e indicados en el manual de instalación, para una adecuada ventilación del producto.
- Averías o desperfectos producidos por transportes o traslados, y manipulación del aparato por personal no autorizado y ajeno a esta empresa o a la marca Pando.
- Golpes, abolladuras, ralladas o rozaduras, cristales rotos.
- Presencia de cuerpos extraños ajenos al aparato, en el interior o exterior del producto.
- Que el técnico no disponga de un fácil acceso al producto, porque hayan elementos que impidan su fácil y seguro acceso. Los medios que se necesitasen para el acceso del técnico Autorizado Pando al aparato serán a cuenta y responsabilidad del usuario.
- Manipulación indebida del cableado eléctrico exterior.
- Componentes estéticos, de uso y desgaste, como pantallas de luz, lámparas, bandejas, parrillas, guías.
- Óxido, quemaduras, manchas o cambios de tonalidad en el cuerpo, puerta, accesorios o cavidad interior producido por mantenimiento o uso inadecuado, o por la aplicación indebida o exposición sin protección a elementos corrosivos como productos de limpieza no recomendados por el fabricante e inadecuados.
- Averías o desperfectos producidos por variaciones de suministro eléctrico o causas fortuitas y naturales de origen atmosférico o geológico como tormentas, rayos, terremotos, inundaciones, etc.
- Aparatos procedentes de reventas, segunda mano, cambio titular original del aparato o de exposiciones que tengan más de dos años desde su fecha de fabricación.

INOXPAN, S.L., queda expresamente excluida de cualquier responsabilidad sobre eventuales daños directos o indirectos a personas o materiales producidos por manipulación indebida del aparato.

Datos de contacto Servicio Técnico Oficial Autorizado Pando:

ESPAÑA, PORTUGAL Y ANDORRA:	OTROS PAÍSES:
<p>ES www.pando.es/asistencia-tecnica/</p> 	<p>EN https://www.pando.es/en/after-sales-services/</p> <p>FR https://www.pando.es/fr/service-apres-vente/</p> 

Em primeiro lugar, queremos agradecer-lhe a confiança depositada na nossa empresa pela aquisição de um dos nossos produtos. Estamos certos de que tomou a decisão mais acertada.

Na Pando, não só oferecemos produtos de primeira qualidade, mas também dispomos de uma equipa de profissionais que o atenderão e o ajudarão em qualquer consulta que se justifique na hora da instalação e ao funcionamento.

Convidamo-lo a visitar a nossa página web (www.pando.es), para nos conhecer melhor, onde poderá ver toda a nossa gama de produtos, com toda a informação técnica e comercial.

Nela encontrará uma ampla seleção de Chaminés Decorativas de parede, de teto, de ilha e de integração. Quatro modos de instalação que nos permitem adaptar a qualquer tipo de cozinha, segundo as necessidades apresentadas.

Também lhe mostramos a nossa coleção de eletrodomésticos, imprescindíveis em qualquer cozinha, tais como: a nova coleção de Fornos e Micro Ondas com elevadas prestações; as Placas de Indução e a Gás que o ajudarão a fazer as melhores receitas; Vinotecas e “caves” de envelhecimento para manter e conservar os seus vinhos nas melhores condições; Máquinas de lavar Loiça de integração, com tecnologia inovadora.

Tudo isto sob uma Marca com uma larguíssima trajetória com mais de 40 anos no mercado; que fabrica os seus produtos como um verdadeiro artesão, espelhando neles o melhor da sua experiência no sentido de satisfazer todas as necessidades dos nossos clientes.

Esperamos sinceramente que se divirta, experimente e desfrute do conforto e das possibilidades do que já é o seu novo aliado na cozinha.
Muito obrigado.

PANDO TEAM

A equipe Pando

1. DESCRIÇÃO DO FORNO	5
2. PAINEL DE COMANDOS	5
3. LIGAR E ACERTAR A HOR	6
4. DESCRIÇÃO DO ECRÃ DE CONTROLO	7
4.1. Ecrã inicial / repouso	7
4.2. Ecrã de seleção.....	8
4.3. Pantalla ecrã de cozinhado	9
5. COZINHADO COM FUNÇÕES TRADICIONAIS	10
5.1. Funções do forno	10
5.2. Para cozinhar com as funções tradicionais	11
5.3. Pré-aquecimento rápido automático.....	11
6. COZINHADO COM ASSESSOR PESSOAL DE COZINHADO (PCA)	12
6.1. Receitas automáticas do forno	12
6.2. Para cozinhar com o assessor pessoal de cozinhado.....	13
6.3. Pré-aquecimento em vazio	14
6.4. Dar a volta aos alimentos.....	14
7. PROGRAMAÇÃO TEMPORIZADA DO FORNO	15
7.1. Opções de temporização	15
7.2. Para programar as opções de temporização.....	16
8. FUNÇÕES DE SEGURANÇA	17
8.1. Bloqueio de segurança para crianças (bloqueio do painel de controlo).....	17
9. FUNÇÃO SCS (Stem Clean System by PANDO)	18
10. FUNÇÃO DEMO (FUNÇÃO ESPECIAL PARA EXPOSIÇÕES)	20
11. ESPECIFICAÇÕES TÉCNICAS	21
12. ESQUEMAS INSTALAÇÃO E COTAS	22
13. CERTIFICADO DE GARANTÍA PANDO	24

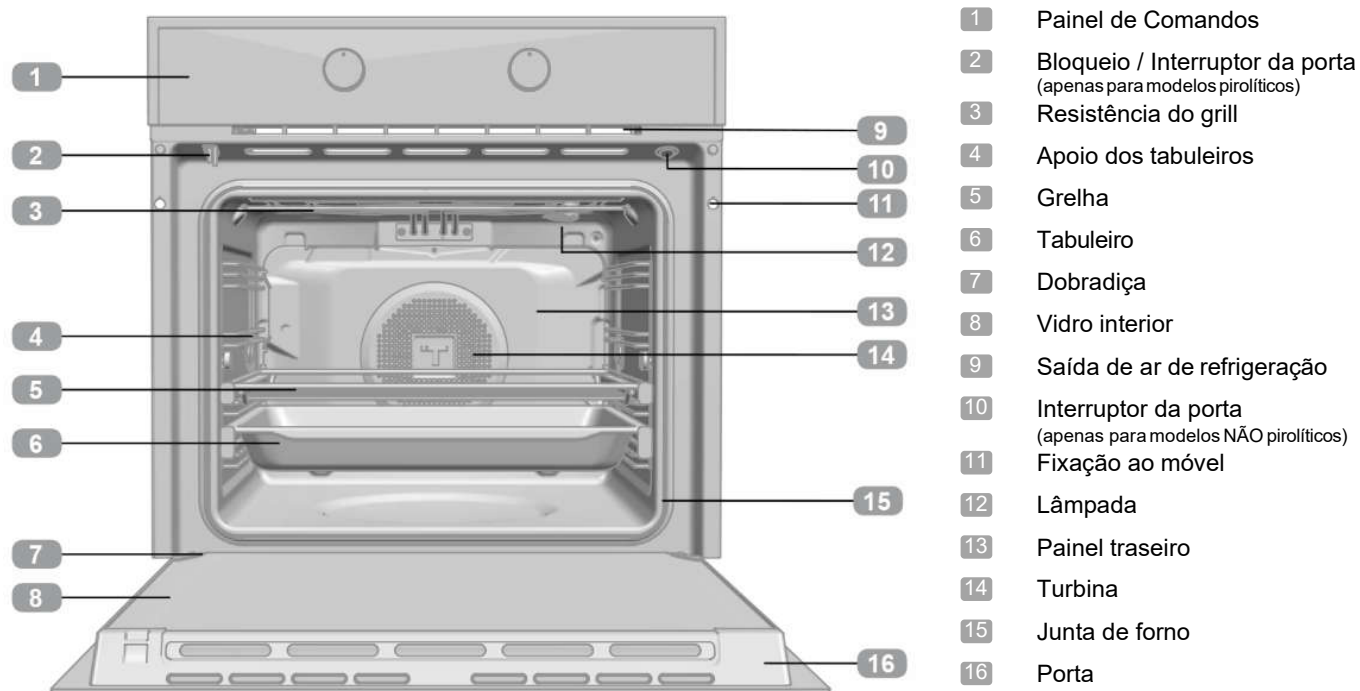
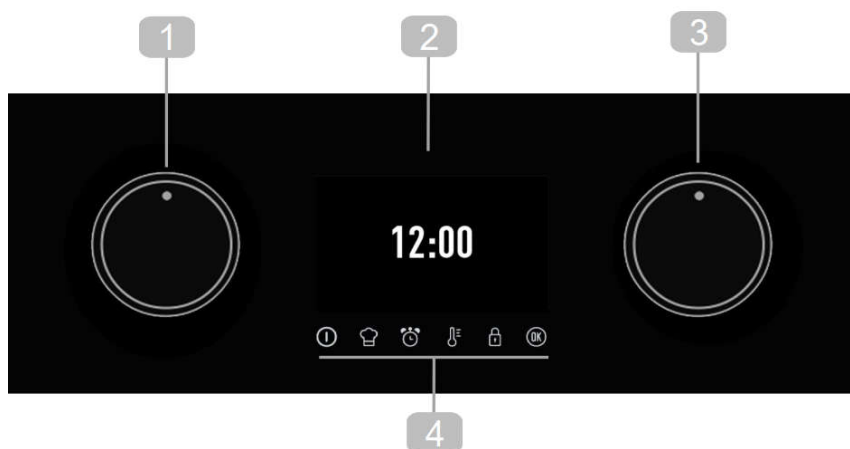
1. DESCRIÇÃO DO FORNO**2. PAINEL DE COMANDOS**

1 Comando para tocar nos menus da parte esquerda do ecrã. Seletor de funções de cozinhado.

2 Ecrã de visualização.

3 Comando para navegar nos menus da parte direita do ecrã. Seletor de ajustes de cozinhado.

4 Teclas.

① **Ligar /desligar o forno.**

🌡️ **Alteração da temperatura do forno.**

👨‍🍳 **Acesso ao assessor pessoal de cozinhado (PANDO CHEF)**

🔒 **Ativação/desativação do bloqueio do teclado/da porta, de acordo com os modelos.**

🕒 **Acesso às funções de temporizador e programação do forno.**



OK **Tecla de validação. Ligar/desligar a luz interior.**

3. LIGAR E ACERTAR A HOR

Ao ligar o forno pela primeira vez, aparecerá o logótipo seguido da indicação 12:00 a piscar.

Para poder trabalhar com o forno, é necessário acertar a hora no relógio.

PARA AJUSTAR A HORA:

- Selecione as horas com o comando esquerdo e os minutos com o comando direito. Valide a seleção com a tecla  ou aguarde uns segundos.
- Selecione com o controle direito o tipo de gráfico para a exibição da hora. Valide la selección con la tecla  o espere unos segundos.

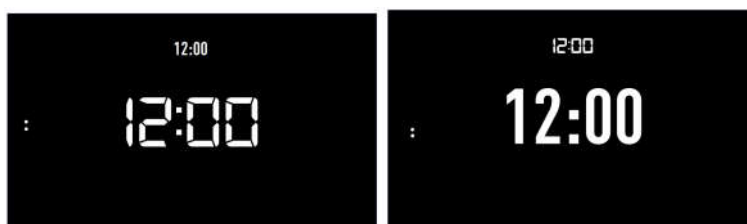

Como confirmação, ouvirá um sinal sonoro e a hora aparecerá fixa no ecrã.

PARA ALTERAR A HORA:

Com o forno em repouso (ecrã inicial), mantenha a tecla  pressionada até que a hora comece a piscar. Siga os passos indicados para alterar a hora.



ATENÇÃO

A sensibilidade das teclas touch adapta-se continuamente às condições ambientais. Ao ligar o forno à corrente, é necessário ter o cuidado de garantir que a superfície do vidro da parte da frente dos comandos está limpa e livre de qualquer obstáculo.

Se, ao tocar no vidro, o ecrã não responder corretamente, é necessário desligar o forno da corrente elétrica e voltar a ligá-lo alguns segundos depois. Desta forma, os sensores ajustar-se-ão automaticamente e reagirão de novo ao tocar com o dedo.



ATENÇÃO

No caso de um corte de corrente elétrica, será apagada toda a programação do relógio eletrónico.

Aparecerá a indicação 12:00.

Pode seguir as instruções anteriores para acertar a hora do relógio.

Se o forno estava com a porta aberta antes do corte de energia, o símbolo de bloqueio acende-se até que a porta desbloqueie.

Isto pode demorar alguns minutos, dependendo da temperatura a que se encontrava o forno, e durante esse tempo não é possível acertar o relógio.

Assim que a porta se desbloquear, poderá acertar o relógio seguindo as instruções anteriores.

4. DESCRIÇÃO DO ECRÃ DE CONTROLO

A seguir descrevemos a informação que encontrará no ecrã de visualização do seu forno e como se apresenta.

4.1. ECRÃ INICIAL / REPOUSO

Este ecrã aparecerá quando o forno não estiver a funcionar, mas estiver ligado à corrente.

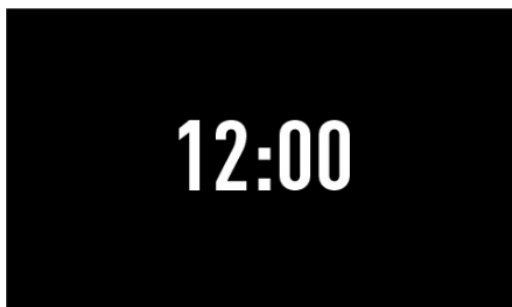

Se o bloqueio do teclado estiver ativo, o símbolo  aparece na parte esquerda do ecrã.

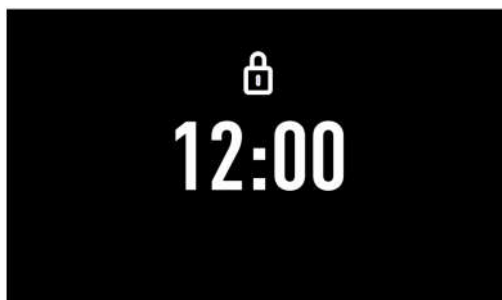

Se houver um aviso programado, o ecrã deixa de mostrar a hora e mostra a contagem decrescente, conforme apresentado na imagem seguinte.

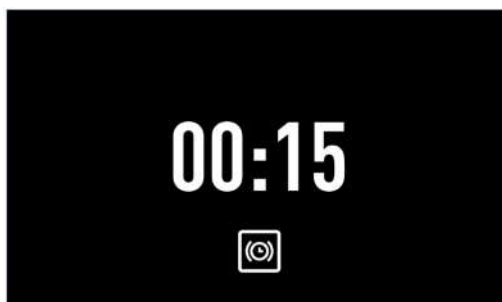

4.2. ECRÃ DE SELEÇÃO

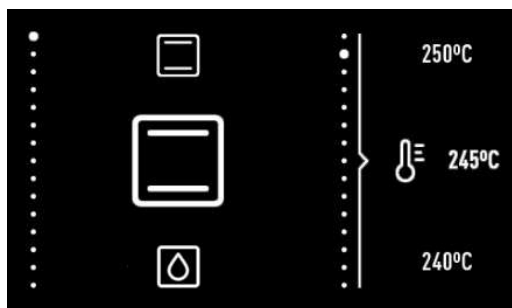

SELEÇÃO DE FUNÇÃO:

- Ligue a unidade usando o botão liga / desliga ①

Enquanto seleciona a função de cozinhado, receita automática ou função do relógio, o ecrã aparece dividido em dois setores:

SETOR ESQUERDO.

Nesta zona do ecrã aparecem as funções de cozinhado, as receitas automáticas ou as funções de programação do relógio disponíveis para seleção.

Para selecionar qualquer uma delas, gire o comando esquerdo até que a função desejada apareça aumentada e valide a seleção com a tecla **OK** (se não selecionar nenhuma tecla, alguns segundos depois o forno validará a seleção automaticamente).

SETOR ESQUERDO.

Nesta zona do ecrã aparecem os valores que se podem ajustar de acordo com a função selecionada: temperatura, peso, duração, hora de finalização, ...

Para selecionar um valor, gire o comando direito até que o valor desejado apareça aumentado e valide a seleção com a tecla **OK** (se não selecionar nenhuma tecla, alguns segundos depois o forno validará a seleção automaticamente).

4.3. PANTALLA ECRÃ DE COZINHADO

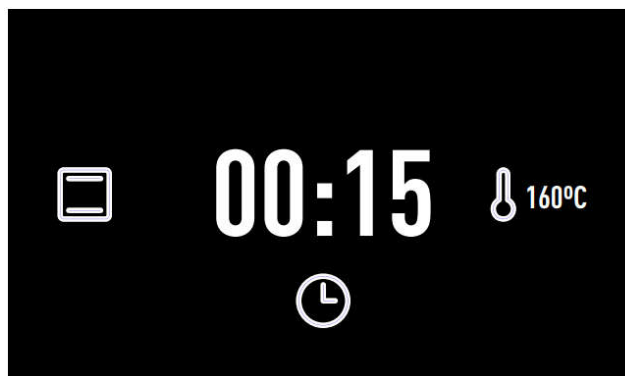

Durante o cozinhado, a informação sobre a situação do forno aparece no ecrã organizada em torno dos círculos centrais:

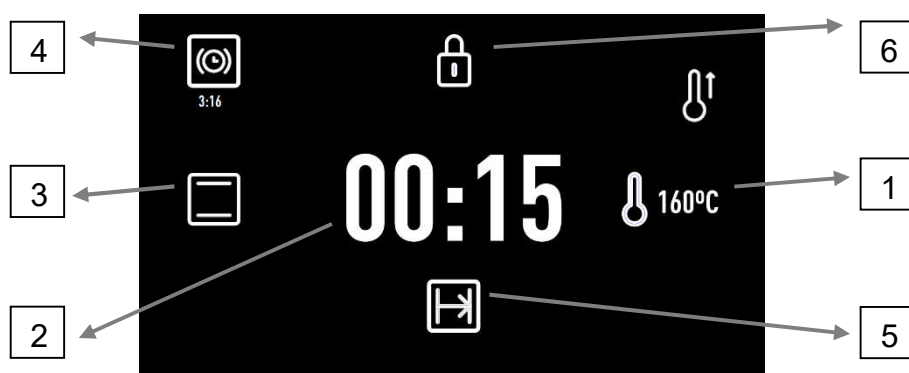

1. Temperatura seleccionada.

O símbolo $\uparrow^{\circ}\text{C}$ piscará vermelho até que se alcance a temperatura seleccionada e sempre que o forno esteja a transmitir calor ao alimento.

2. Duração do cozinhado.

Se não programou o relógio, aparecerá o tempo a que o forno está a cozinhar.

Se fez alguma programação, mostrará o tempo que falta para que o cozinhado finalize (contagem decrescente)

Se o forno não está programado e está em modo de espera (ainda não começou a cozinhar), aparecerá a duração total do cozinhado programado.

3. Função de cozinhado ou receita automática seleccionada.

Se programou funções de tempo, a informação referente a estas funções aparece na zona direita do ecrã.

4. **Avisador.** Faz a contagem decrescente para a finalização do aviso programado.

5. **Hora de finalização.**

Se você ativou as funções de segurança, as informações relacionadas a esta função são exibidas na tela.

6. **Bloqueio do teclado.** Iluminar-se-á quando o bloqueio de segurança para crianças estiver ativado.

5. COZINHADO COM FUNÇÕES TRADICIONAIS**5.1. FUNÇÕES DO FORNO****INFORMAÇÃO**

Para una descripción de uso de cada una de las funciones, consulte la guía de cocinados incluida en su horno.

**DESLIGAR****CONVENCIONAL** **CONVENCIONAL COM TURBINA** **GRILL E RESISTÊNCIA INFERIOR** **MAXIGRILL****GRILL****RESISTÊNCIA INFERIOR** **PIZZA** **TURBO** **A LUME BRANDO****FERMENTAR MASAS****DESCONGELAÇÃO****ECO****HYDROCLEAN (STEAM CLEANING SYSTEM BY PANDO)****Funções que incorporam pré-aquecimento rápido automático**

5.2. PARA COZINHAR COM AS FUNÇÕES TRADICIONAIS

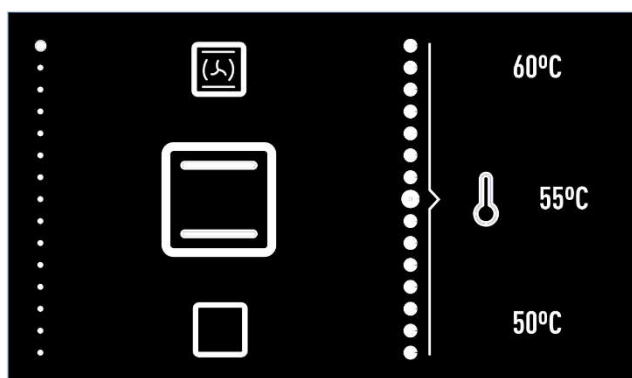

Seleção de função.

Ligue o forno premindo a tecla .



Gire o comando esquerdo até que a função desejada apareça aumentada.

A seguir, aparecerá à direita a temperatura recomendada para a função escolhida.

Se desejar, pode alterar a temperatura ao girar o comando direito

Valide a seleção com a tecla . O forno começará a cozinhar.

A qualquer momento durante o cozinhado pode:

- **Alterar a função de cozinhado**, girando o comando esquerdo.
- **Modificar a temperatura do cozinhado** girando o comando direito.
- **Programar um aviso ou uma duração/ hora de término do cozinhado**. Premindo a tecla .
- **Alterar a programação de avisos ou duração/hora de término programados**. Premindo a tecla .



INFORMAÇÃO

Para programar ou modificar uma programação, consulte a secção «Programação temporizada do cozinhado», que encontrará mais adiante neste guia de utilização.



























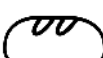





5.3. PRÉ-AQUECIMENTO RÁPIDO AUTOMÁTICO

As funções assinaladas incorporam pré-aquecimento rápido automático.

Durante o pré-aquecimento rápido, o símbolo  ilumina-se.

Recomendamos que não coloque os alimentos até que o símbolo se apague.

6. COZINHADO COM ASSESSOR PESSOAL DE COZINHADO (PCA)**6.1. RECEITAS AUTOMÁTICAS DO FORNO**

AVES			FRANGO		
			PATO		
			GANSO		
			PERU		
CARNES			LEITÃO		
			BOI		
			BORREGO		
			COSTELETAS		
PEIXES			PESCADO		
			SALMÃO		
PÃO			PÃO BRANCO		
			PÃO DE MISTURA		
			PÃO INTEGRAL		
PIZZAS			PIZZA COM MASSA ALTA		
			PIZZA COM MASSA FINA		
SOBREMESAS			BOLO DE FORMA		
			BOLO DE FRUTAS GRANDE		
			BOLO DE FRUTAS PEQUENO		
			BOLO EM TABULEIRO		

 Receitas que requerem o pré-aquecimento do forno em vazio.

 Receitas que requerem dar a volta ao alimento.

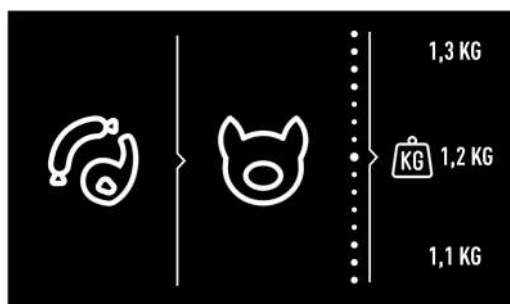
6.2. PARA COZINHAR COM O ASSESSOR PESSOAL DE COZINHADO

Seleção de receita.

Gire o comando esquerdo até que o tipo de alimento que pretende cozinhar apareça aumentado.

A seguir, no setor direito do ecrã, aparecerão as receitas disponíveis para o tipo de alimento selecionado. Selecione com o comando direito a receita desejada e valide a seleção com a tecla **OK**.

A seguir, no setor direito do ecrã, aparecerá a informação que o forno precisa para programar o cozinhado.

De acordo com a receita selecionada, o forno pedirá que indique:

PESO DO ALIMENTO: selecione com o comando direito e valide com a tecla **OK**.

TEMPERATURA: valide a temperatura proposta pela receita ou selecione outra com o comando direito e confirme com a tecla **OK**.

TIPO DE ACABADO: em alguns cozinhados, pode selecionar o tipo de acabamento:

HIGH: Acabamento bem passado

MEDIUM: Acabamento no ponto

LOW: Acabamento mal passado

Uma vez selecionados todos os parâmetros, valide com a tecla **OK**.

O forno começará a cozinhar e o ecrã de seleção dará lugar ao ecrã de cozinhado, onde poderá ver a seguinte informação:

- Temperatura de cozinhado selecionada
- Tempo de cozinhado em falta
- Receita selecionada

Uma vez concluído o cozinhado, soará um alarme sonoro durante cerca de 90 segundos e no ecrã o símbolo de cozinhado ficará a piscar. Prima qualquer tecla para parar o som.

O forno apagar-se-á automaticamente.

**INFORMAÇÃO**

Durante os primeiros 10 minutos do cozinhado, poderá alterar o peso e tipo de acabamento ou programar uma hora de finalização do cozinhado.

Decorrido este tempo, os valores ficam fixos e não poderão ser alterados.

Para alterar estes valores de cozinhado, prima a tecla **↵** e o forno voltará ao ecrã de seleção.

Siga os passos indicados anteriormente.

A qualquer momento durante o cozinhado pode:

Alterar a temperatura do cozinhado, premindo a tecla **⬇** Valide com a tecla **OK**.

Programar um aviso. Premindo a tecla **⬇**.

Alterar a programação de um aviso programado. Premindo a tecla **⬇**.

Para programar, ou alterar uma programação, siga as instruções da secção «Programação temporizada do cozinhado», que encontrará mais adiante neste guia de utilização.

6.3. PRÉ-AQUECIMENTO EM VAZIO



As receitas indicadas na tabela com o símbolo  requerem colocar o alimento com o forno já aquecido.

Quando seleccionar uma destas receitas, ao começar o cozinhado, aparecerá o símbolo  no ecrã. Quando o forno atingir a temperatura de cozinhado, o símbolo pisca e soa um alarme para avisar que já pode colocar o alimento.

O alarme desliga-se automaticamente ao abrir a porta do forno para colocar o alimento e no ecrã de cozinhado aparece o tempo restante.

6.4. DAR A VOLTA AOS ALIMENTOS

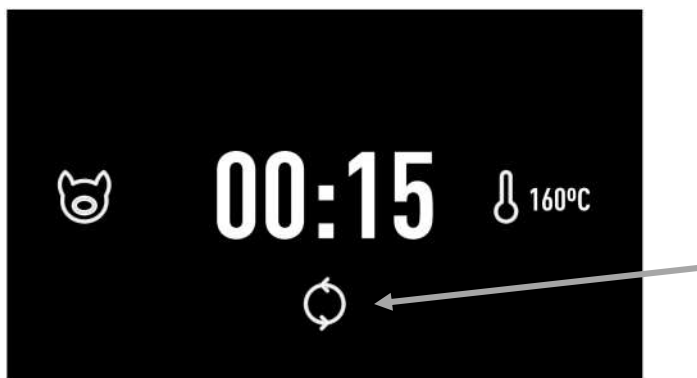

As receitas indicadas na tabela com o símbolo  requerem dar a volta ao alimento durante o cozinhado.

O forno avisá-lo-á quando o deve fazer com um alarme sonoro e, no ecrã de cozinhado, aparecerá o símbolo .

O alarme desliga-se automaticamente ao abrir a porta do forno para dar a volta ao alimento.

7. PROGRAMAÇÃO TEMPORIZADA DO FORNO

7.1. OPÇÕES DE TEMPORIZAÇÃO

Dispõe das seguintes opções de temporização para programar um cozinhado:

 **Avisador:** criar um alarme para soar ao finalizar o tempo programado. O cozinhado NÃO termina quando termina o tempo. Também pode criar um aviso para quando o forno não está a cozinhar.



INFORMAÇÃO

Pode programar um Aviso, em qualquer momento, independentemente do forno estar ou não a cozinhar.

As restantes opções de temporização só estão disponíveis quando o forno estiver a cozinhar.

 **Duração do Cozinhado:** permite seleccionar o tempo que o forno vai estar a cozinhar.



Finalizado o tempo programado, soará um alarme, o símbolo  piscará e o forno deixará de aquecer de forma automática.

Prima qualquer tecla para parar o alarme e desligar o forno.

 **hora de Finalização do Cozinhado:** permite seleccionar a hora até à qual o forno estará a cozinhar.

Ao chegar à hora programada, soará um alarme, o símbolo  piscará e o forno deixará de aquecer de forma automática.

Prima qualquer tecla para parar o alarme e desligar o forno.

- **Início do cozinhado guardado ( Duração +  hora de Finalização do Cozinhado):** Permite programar o forno para que comece o cozinhado de forma automática e se desligue também de forma automática, uma vez transcorrido o tempo de cozinhado programado.



INFORMAÇÃO

Para programar esta opção, deverá programar consecutivamente a Duração e a Hora de Finalização do Cozinhado.

Poderá aceder às opções de programação em qualquer momento do cozinhado.

Da mesma forma, poderá alterar uma programação já estabelecida.

10 segundos antes de iniciar o programa de temporização, você ouvirá um bipe sonoro que pode cancelar o pulsar do botão qualquer.

Ao encerrar a programação, você deve emitir um bipe sonoro que pode cancelar a pulsação de qualquer botão.

Se você não pressionar o botão, o bipe sonoro será emitido por 2 minutos.



INFORMAÇÃO

Se seleccionou uma receita automática, o forno determinará automaticamente a Duração do cozinhado, pelo que esta opção não estará disponível.

Porém, neste caso poderá:

Programar a Hora de Finalização durante os primeiros dez minutos do cozinhado.

Programar em qualquer momento um aviso.

7.2. PARA PROGRAMAR AS OPÇÕES DE TEMPORIZAÇÃO

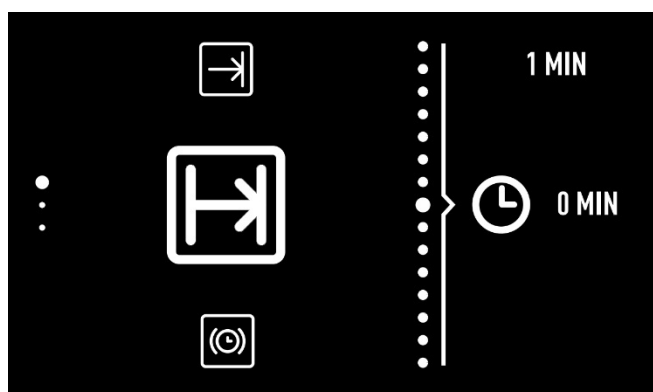

Programação duração do cozinhado

1. Prima a tecla  para aceder ao menu de opções de temporização.
2. Gire o comando esquerdo para seleccionar a opção de programação desejada.
3. Gire o comando direito para seleccionar a duração ou a hora de finalização de acordo com a opção escolhida.



INFORMAÇÃO

O forno não permitirá seleccionar uma hora de finalização anterior à hora atual.

Quando a hora de finalização estiver programada, aparecerá na zona central a hora atual para facilitar a seleção.



1. Valide a seleção com a tecla .
2. A seguir, voltará a aparecer o ecrã de cozinhado. Poderá ver as temporizações programadas à direita do círculo central.

8. FUNÇÕES DE SEGURANÇA

8.1. BLOQUEIO DE SEGURANÇA PARA CRIANÇAS (BLOQUEIO DO PAINEL DE CONTROLO)

Esta função pode ser ativada a qualquer momento:

- **Com o forno apagado.** O bloqueio para crianças não permitirá que o forno seja ligado ao premir a tecla .
- **Durante o uso do forno.** Se ativar a função enquanto o forno cozinha ou está em espera, ficará bloqueada a resposta do teclado e dos comandos e nenhum valor do cozinhado se poderá alterar.

Para ativar a função, prima a tecla  prolongadamente até que soe 1 sinal sonoro e o símbolo  seja apresentado no visor. O painel de controlo está bloqueado.

Para desativar a função, prima de novo a tecla  prolongadamente até que soe 1 sinal sonoro e o símbolo  desapareça.

9. FUNÇÃO SCS (Stem Clean System by PANDO)

Esta função facilita a limpeza de gordura e restos de sujidade que tenham aderido às paredes do forno.

Para facilitar a limpeza, evite a acumulação de sujidade. Limpe frequentemente o forno.

PROGRAMAR A FUNÇÃO SCS

⚠ ATENÇÃO

Não verta água no interior do forno ainda quente, pois poderá danificar o esmalte do mesmo.

Realize sempre o ciclo com o forno frio. Se o procedimento for efetuado com o forno demasiado quente, poderá haver alterações no resultado e poderá danificar o esmalte.

Retire previamente os tabuleiros e todos os acessórios do interior do forno, incluindo os suportes dos tabuleiros ou as guias telescópicas.

Para tal, siga as instruções presentes no manual de instalação e manutenção fornecido com o forno:

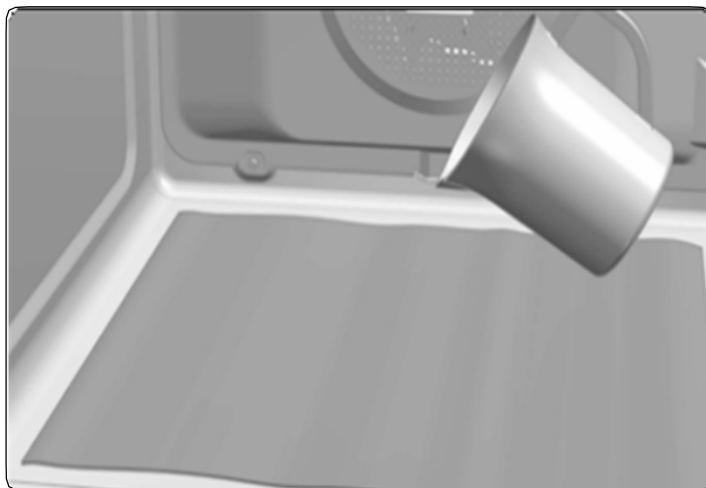

1. Com o forno frio, coloque um pano estendido na base do forno.





2. Verta lentamente 200 ml de água na parte inferior da cavidade do forno.

📖 INFORMAÇÃO

Para melhores resultados, adicione uma colher de sobremesa de detergente suave para a loiça no copo de água antes de o verter no pano.

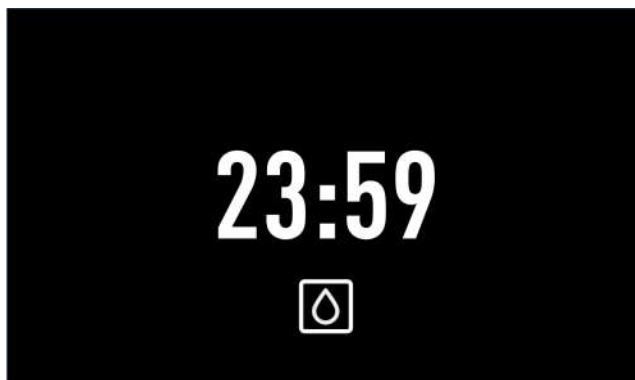
3. Ligue o forno, gire o comando esquerdo para selecionar a função  e valide com .
4. A seguir ouvirá um sinal sonoro que confirma que a função SCS já começou.
No ecrã, será apresentado o símbolo  e o tempo restante para que termine a função.
O tempo de duração é predefinido para 24 minutos.

**IMPORTANTE**

Não é possível alterar a duração desta função. Para terminar antes, desligue o forno com a tecla .

5. Assim que for atingida a hora de finalização, o forno desligar-se-á, será emitido um sinal sonoro e o símbolo  piscará rapidamente.

**IMPORTANTE**

Não abra a porta do forno até que a função SCS finalize.
A fase de arrefecimento é necessária para o correto funcionamento da função.

6. Prima qualquer tecla com o dedo para parar o sinal sonoro e apagar o símbolo .
7. O forno apagar-se-á automaticamente.
8. O forno está pronto para retirar os restos de sujidade e a restante água com o pano.

A função SCS é realizada a baixa temperatura. No entanto, o tempo de arrefecimento pode variar de acordo com a temperatura ambiente.

**ATENÇÃO**

Antes de tocar diretamente na superfície interior do forno, certifique-se de que este se encontra a uma temperatura adequada.



Se após a realização da função SCS for necessária uma limpeza mais profunda, utilize detergentes neutros e esponjas não abrasivas.

10. FUNÇÃO DEMO (FUNÇÃO ESPECIAL PARA EXPOSIÇÕES)

Com a função DEMO ativada, pode usar o for- no sem aquecer.

É recomendável ativar esta função quando o forno é instalado numa exposição com ligação à corrente.

Ativação da função DEMO

Antes de acertar o relógio, clique em simultâneo nas teclas  e  e , até que no ecrã apareça a indicação «DEMO Mode ON».

A seguir acerte a hora no forno.

A palavra «DEMO» aparecerá de forma permanente no ecrã e o forno pode trabalhar normalmente, mas sem aquecer.

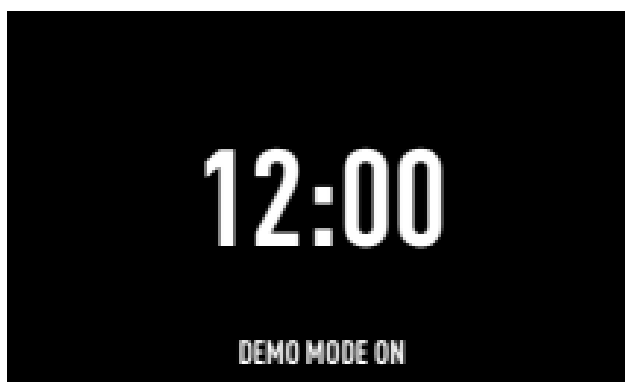

Para desativar a função DEMO, deve desligar o forno da corrente.

11. ESPECIFICAÇÕES TÉCNICAS

INSTALAÇÃO	PHT-941	PHT-963
tensão (V)	220-240	220-240
Frecuência (Hz)	50/60	50/60
Cabo de energia (m)	1,1 m SEM PLUGUE	1,1 m SEM PLUGUE
Dimensões de montagem (altura x largura x profundidade) (mm)	450-460 x 560-568 x 580	590-600 x 560-568 x 580
Dimensões do produto no painel frontal (altura x largura x profundidade) (mm)	430x545x537	570x545x537
LOGÍSTICA / EMBALAGEM		
Peso Líquido (Kg)	25	32
Peso Bruto (Horno+Emb) (Kg)	27	34
Dimensões da embalagem (altura x largura x profundidade) (mm)	510x635x655	650x635x655
ACCESÓRIOS		
Manual de Instruções - Idiomas (2)	ES/PT/UK/FR/GE	ES/PT/UK/FR/GE
Bandeja Plana 30	1	1
Bandeja Profunda 50	1	1
Grelha reforçada	1	1
FUNCIONALIDADES		
Volume Útil (1) (L)	44	70
Volume Interior Global (1) (L)	45	71
Superfície de cozimento útil (1) (cm ²)	1280	1280
Faixa de temperatura	30-270 °C	30-270 °C
VALORES DE ENERGIA ELÉTRICA		
Resistências		
Grill + Topo	1.400 W +1.100 W	1.400 W +1.100 W
inferior	1.150 W	1.150 W
Traseira	1800	2000
Motor Turbo	22	22
Motor do refrigeração	18 W	18 W
Poder da iluminação	25 W	25 W
ILUMINAÇÃO		
LUZ INERIOR	HALOGEN	HALOGEN
FUNÇÃO MÁXIMA DE ENERGIA	Bottom + TURBO (Pizza)	Bottom + TURBO (Pizza)
Potência máxima do forno (230 V)	3015 W	3215 W
CONSUMO DE ENERGIA (1) (3) -		
Função mais eficiente	ECO	ECO
Índice de Eficiência Energética (IEE)	80,8	81
Classe de eficiência energética	A+	A+
MARCAS E CERTIFICADOS	CE / N / CCA / CB / EAC / G - Mark	CE / N / CCA / CB / G - Mark

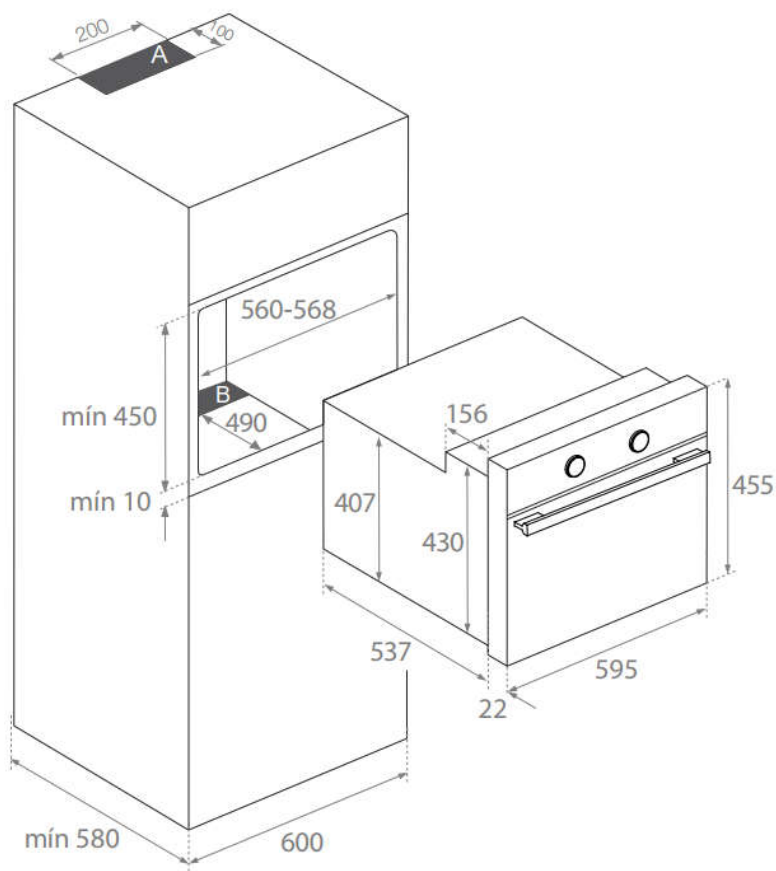
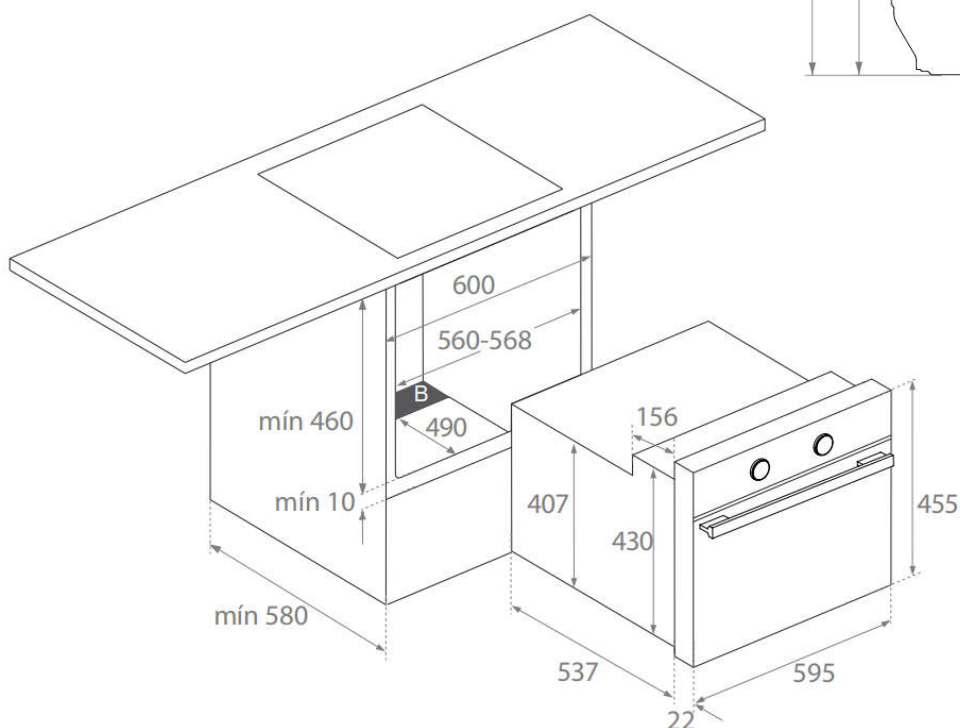
12. ESQUEMAS INSTALAÇÃO E COTAS**PHT 941****INSTALAÇÃO EM COLUNA****INSTALAÇÃO SOB A BANCADA****⚠ ATENÇÃO**

Respeite os orifícios de ventilação no gabinete, consulte os desenhos de instalação (200x100mm na zona **A** e 560X90mm na zona **B**).

Se essas aberturas não estiverem disponíveis, o produto não funcionará corretamente e pode sofrer danos que **NÃO** seriam cobertos pela garantia.

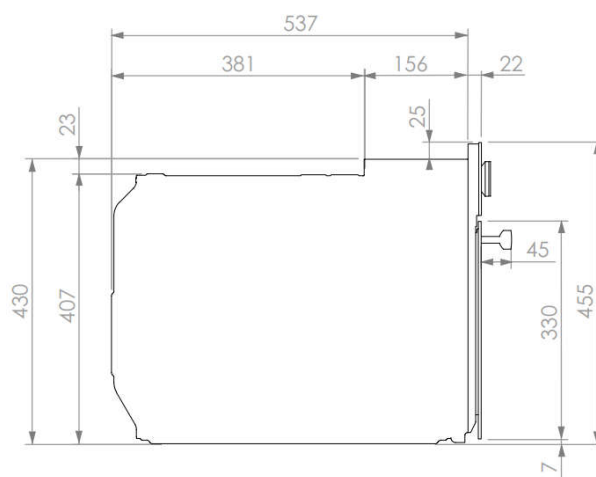

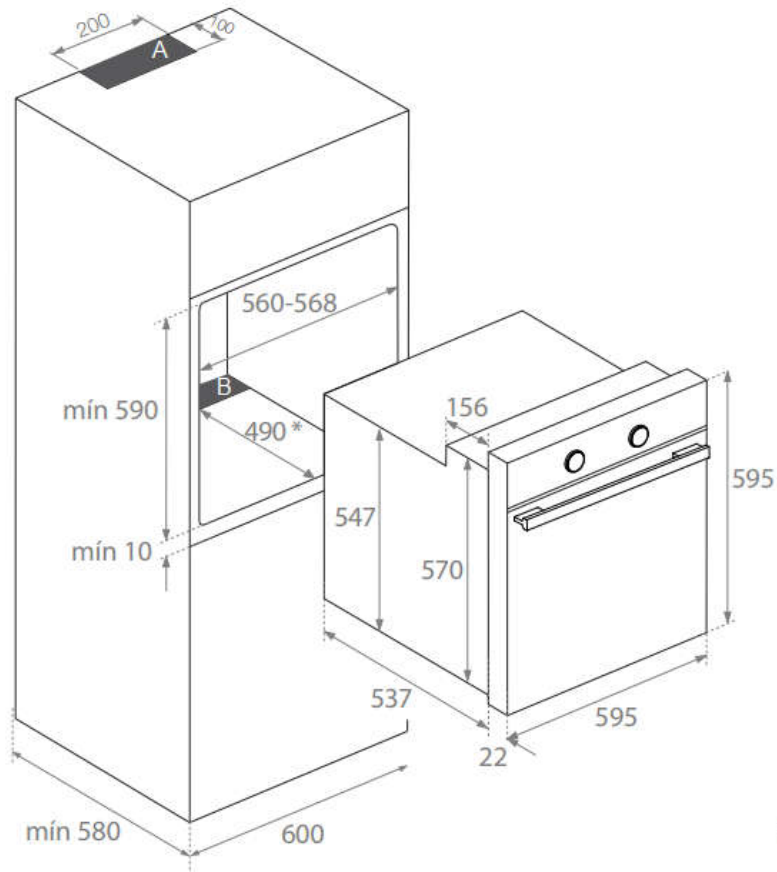
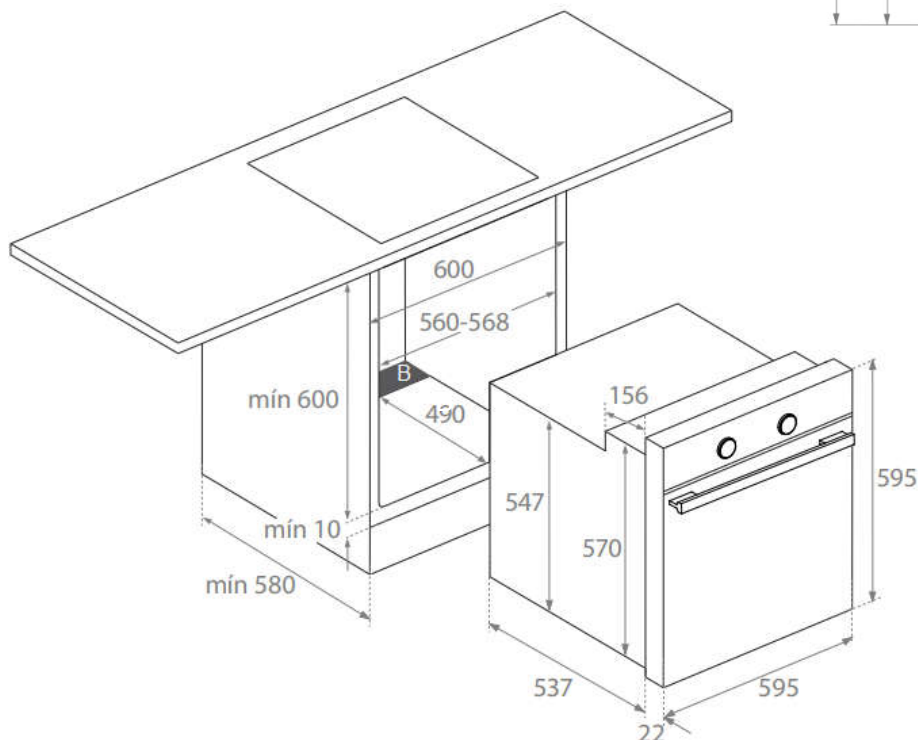
12. ESQUEMAS INSTALAÇÃO E COTAS**PHT 963****INSTALAÇÃO EM COLUNA****INSTALAÇÃO SOB A BANCADA****⚠️ ATENÇÃO**

Respeite os orifícios de ventilação no gabinete, consulte os desenhos de instalação (200x100mm na zona **A** e 560X90mm na zona **B**).

Se essas aberturas não estiverem disponíveis, o produto não funcionará corretamente e pode sofrer danos que **NÃO** seriam cobertos pela garantia.

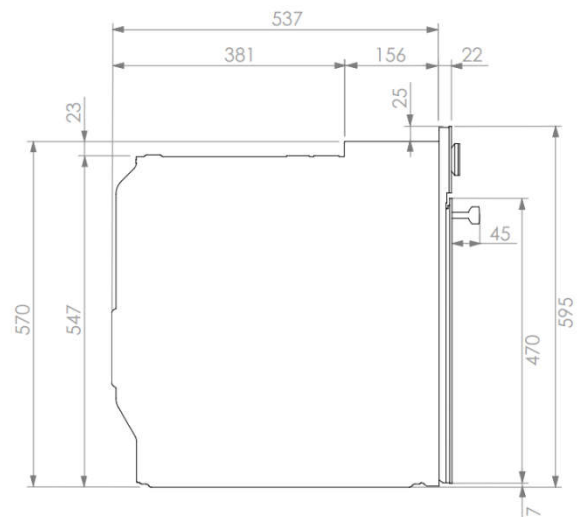

13. CERTIFICADO DE GARANTÍA PANDO

INOXPAN S.L., agradece a escolha e a confiança depositada num produto da nossa marca Pando, que se distingue pela sua Qualidade, Design e inovação sendo fiel às suas origens e compromisos.

CONDIÇÕES DE GARANTIA PANDO:

Este aparelho dispõe de uma garantia de 3 anos a partir da data da compra e cobre este aparelho contra todo o defeito de fabricação que afecte o seu funcionamento. Para a validade da mesma é imprescindível apresentar a factura ou ticket de compra ao técnico do Serviço Oficial Autorizado Pando.

Durante o referido período, a Empresa compromete-se a repor ou reparar gratuitamente qualquer peça defeituosa devido a erro ou defeito de fabricação do aparelho, até se conseguir o seu funcionamento correto, bem como a mão de obra necessária e os gastos ocasionados como consequência da reparação ou reposição.

EXCLUSÕES DE GARANTIA PANDO:

Não estará coberto pela garantia ou poderia ser causa de anulação da mesma, devendo debitar-se aos clientes os custos de mão de obra e dos materiais, deslocação do serviço técnico, **perantes os seguintes presupostos:**

- Revisões de instalação ou funcionamento, limpezas ou manutenção.
- Se a instalação do dispositivo não tiver sido realizada pelo pessoal especialista profissional autorizado ou pelo serviço técnico oficial da Pando, que atendem aos requisitos das normas de segurança e dos regulamentos de energia elétrica.
- Quando o aparelho se destine a uso comercial e Não doméstico, para o qual não está previsto.
- Mau funcionamento do produto por incumprimento das normas, instruções e recomendações indicadas no manual do aparelho.
- Mau funcionamento ou problemas causados por uma instalação inadequada ou por não possuir os espaços livres necessários nos móveis e indicados no manual de instalação, para ventilação adequada do produto.
- Avarias ou defeitos produzidos por transportes ou mudanças, e manuseamento do aparelho por pessoal não autorizado e alheio a esta empresa ou à marca Pando.
- Pancadas amolgadelas, riscos ou razuras, vidros partidos.
- Presença de corpos estranhos alheios ao aparelho, no interior ou no exterior do produto.
- Que o técnico não tenha acesso fácil ao produto, porque têm elementos que impedem um fácil e seguro acesso. Os meios que forem necessários para o acesso do técnico do SAT ao aparelho serão por conta e responsabilidade do usuário.
- Manipulação incorreta das cablagens e ligações do cabo elétrico externo.
- Componentes estéticos, de uso e desgaste, como mostradores de luz, lampadas, bandejas, grelhadores, guias.
- Óxido, queimaduras, manchas, ou alterações de cor no corpo, porta, acessórios ou cavidade interna causadas por manutenção ou uso inadequado, ou por aplicação inadequada ou exposição desprotegida a elementos corrosivos, como produtos de limpeza não recomendados pelo fabricante e inadequados.
- Avarias ou defeitos produzidos por variações de corrente eléctrica ou causas frutuitas e naturais de origem atmosférica ou geológicos como tempestades, raios, terremotos, inundações.
- Aparelhos procedentes de revendas, segunda mão, mudança de titular original ou exposições que tenham mais de dois anos desde a sua data de fabricação.

INOXPAN, S.L., fica expressamente excluída de qualquer responsabilidade sobre eventuais danos directos ou indirectos, a pessoas ou materiais produzidos por manipulação indevida do aparelho.

Datos de contacto Serviço Técnico Oficial Autorizado Pando:

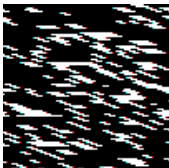
ESPAÑA, PORTUGAL Y ANDORRA:	OTROS PAÍSES:
<p>ES www.pando.es/asistencia-tecnica/</p> 	<p>EN https://www.pando.es/en/after-sales-services/</p> <p>FR https://www.pando.es/fr/service-apres-vente/</p> 

Tout d'abord, nous tenons à vous remercier pour la confiance accordée à notre entreprise pour l'acquisition d'un de nos produits. Nous sommes convaincus que vous avez pris la bonne décision.

Chez Pando, nous offrons non seulement des produits de qualité supérieure, mais nous avons également une grande équipe de professionnels qui vous assisteront et vous conseilleront sur toute question pouvant survenir au moment de l'installation ou de l'exploitation.

Nous vous invitons également à visiter notre site Web (www.pando.es/fr) pour mieux nous connaître et où vous pouvez retrouver toute nos gammes de produits avec les informations commerciales et techniques nécessaires.

Vous y trouverez une large sélection de hottes décoratives murales, plafond, îlot et intégration. Quatre types d'installation qui nous permettent de nous adapter à tout type de cuisine en fonction des besoins qui se présentent.

Nous vous montrons également notre collection d'appareils électroménagers essentiels dans n'importe quelle maison. Des appareils tels que notre collection de fours et micro-ondes à hautes performances, des plaques à induction et à gaz qui vous aideront à réaliser les meilleures recettes, des caves à vin pour entretenir et conserver vos vins dans les meilleures conditions et des lave-vaisselle de intégration avec les dernières technologies disponibles.

Tout cela sous une marque avec une très longue histoire de plus de 40 ans sur le marché, qui fabrique ses produits comme un véritable artisan. Nous y concentrons le meilleur de notre expérience pour satisfaire tous vos besoins.

Nous espérons sincèrement que vous vous amuserez, expérimenterez et apprécierez le confort et les capacités de votre nouvel allié de cuisine.

Merci beaucoup

L'équipe Pando

1. DESCRIPTION DU FOUR	5
2. PANNEAU FRONTAL DES COMMANDES	5
3. ALLUMAGE ET REGLAGE DE L'HEUR	6
4. DESCRIPTION DE L'ECRAN DE CONTROLE	7
4.1. Écran d'accueil / veille.....	7
4.2. Écran de sélection	8
4.3. Écran de cuisson.....	9
5. CUISSON AVEC DES FONCTIONS TRADITIONNELLES	10
5.1. Fonctions du four	10
5.2. Pour cuisiner avec les fonctions traditionnelles	11
5.3. Préchauffage rapide automatique	11
6. CUISSON AVEC L'ASSISTANT PERSONNEL DE CUISSON (PANDO CHEF)	12
6.1. Recettes automatiques du four	12
6.2. Pour cuisiner avec l'assistant personnel de cuisson	13
6.3. Préchauffage a vide	14
6.4. Retourner l'aliment	14
7. PROGRAMMATION AVEC MINUTERIE DU FOUR	15
7.1. Options de minuterie	15
7.2. Pour programmer les options de minuterie.....	16
8. FONCTIONS DE SECURITE	17
8.1. Verrouillage de sécurité pour les enfants (verrouillage du panneau de contrôle).....	17
9. FONCTION SCS (Stem Clean System by PANDO)	18
10. MODE DEMO (Fonction spéciale pour les expositions)	20
11. SPÉCIFICATIONS TECHNIQUES	21
12. SCHÉMAS ET DIMENSIONS D'INSTALLATION	22
13. SERVICE TECHNIQUE APRÈS-VENTE (SAT) ET GARANTIE	24

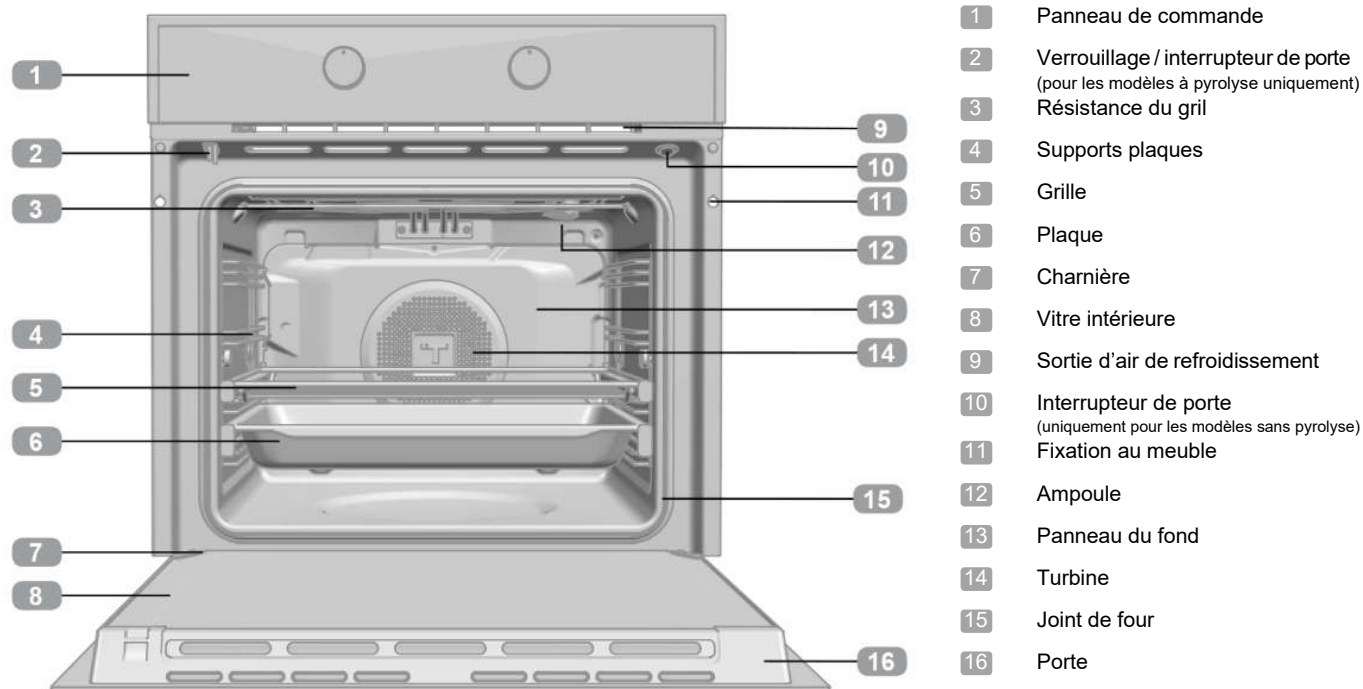
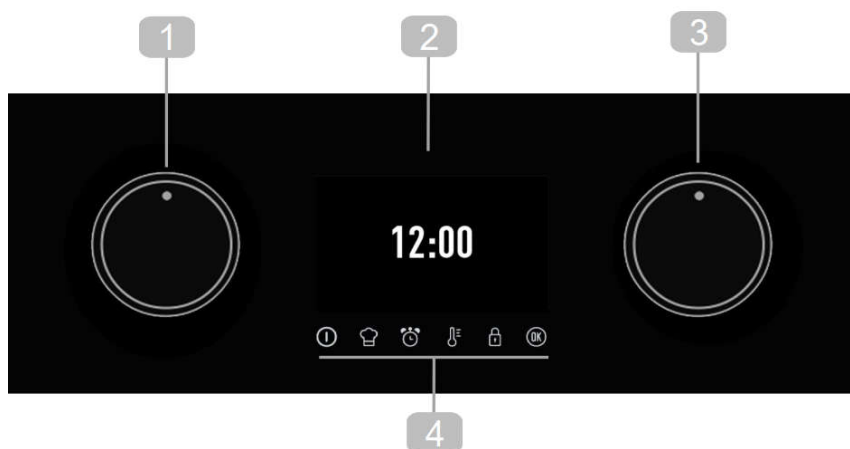
1. DESCRIPTION DU FOUR**2. PANNEAU FRONTAL DES COMMANDES**

- 1 Commande pour parcourir les menus de la partie gauche de l'écran. Sélecteur de modes de cuisson.
- 2 Écran d'affichage.
- 3 Commande pour parcourir les menus de la partie droite de l'écran. Sélecteur des réglages de cuisson.
- 4 Touches.

① **Allumage/ arrêt du four.**

🌡️ **Modification des températures du four.**

👨‍🍳 **Accès à l'assistant personnel de cuisson (PANDO CHEF).**

🔒 **Activation/désactivation du verrouillage du clavier / porte selon les modèles.**

🕒 **Accès aux fonctions de minuterie et de programmation du four.**

OK **Touche de validation.**



Arrêt / allumage de la lumière intérieure.

3. ALLUMAGE ET REGLAGE DE L'HEURE

Lorsque vous branchez le four pour la première fois au secteur, le logo apparaît suivi de l'indication clignotante 12:00.

Pour pouvoir utiliser le four, il est nécessaire de mettre l'horloge à l'heure.

RÉGLAGE DE L'HEURE:

- Sélectionnez les heures avec la commande de gauche et les minutes avec la commande de droite. Validez la sélection avec la touche  ou attendez quelques secondes.
- Sélectionnez avec la commande de droite le type de graphique pour l'affichage des heures.
- Validez la sélection avec la touche  ou attendez quelques secondes.

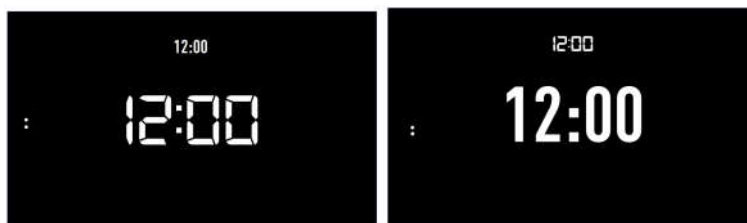

Un signal sonore est émis pour confirmer et l'heure se fixe sur l'écran.

Pour modifier l'heure:

Avec le four en veille (écran d'accueil), maintenez la touche  enfoncée jusqu'à ce que l'heure se mette à clignoter. Suivez les étapes décrites pour modifier l'heure.



MISE EN GRANDE

La sensibilité des touches tactiles s'adapte constamment aux conditions ambiantes. Lorsque vous branchez le four au secteur électrique, veillez à ce que la surface vitrée du tableau de commande soit propre et sans aucun obstacle.

Si l'écran ne répond pas correctement lorsque vous touchez la vitre avec le doigt, il faut débrancher le four du secteur électrique et le rebrancher après un court instant. Ceci permet de régler automatiquement les capteurs qui réagiront de nouveau lorsque vous toucherez les commandes tactiles.



MISE EN GRANDE

En cas de coupure de courant, toute la programmation de l'horloge électronique est annulée. L'indication 12:00 apparaîtra.

Vous pourrez mettre l'horloge à l'heure en suivant les instructions précédentes.

Si la porte du four était verrouillée avant la coupure de courant, le symbole de verrouillage s'allumera jusqu'à ce que la porte se déverrouille.

Cela peut prendre plusieurs minutes en fonction de la température du four ; pendant ce temps, vous ne pourrez pas mettre l'horloge à l'heure.

Une fois la porte déverrouillée, vous pourrez mettre l'horloge à l'heure en suivant les instructions précédentes.

4. DESCRIPTION DE L'ÉCRAN DE CONTRÔLE

Veillez trouver ci-dessous la description de l'information s'affichant sur l'écran d'affichage de votre four et de la façon dont elle s'affiche.

4.1. ÉCRAN D'ACCUEIL / VEILLE

Cet écran apparaît lorsque le four ne fonctionne pas mais qu'il est branché au secteur.

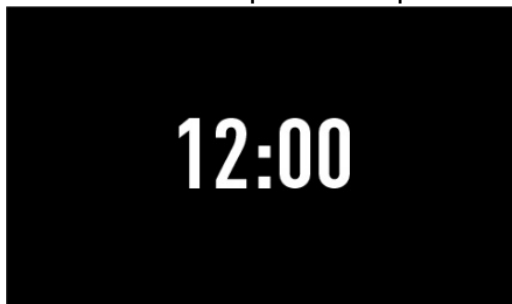

Si le verrouillage du clavier est activé, le symbole  s'affichent sur la partie haut de l'écran.

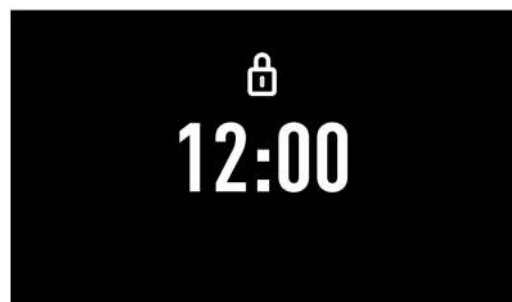

Si vous avez programmé une alarme, l'écran affiche un compte à rebours à la place de l'heure, comme sur l'image suivante.

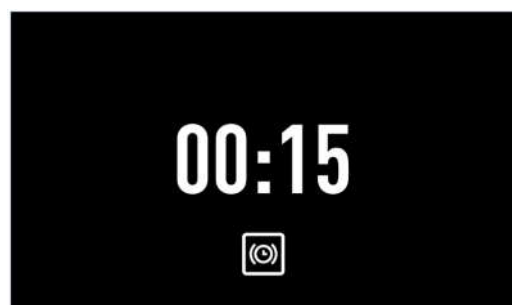

4.2. ÉCRAN DE SÉLECTION

SELECTEUR DE FONCTION:

- Démarrez l'unité avec le bouton d'alimentation ON/OFF ①

Pendant la sélection d'une fonction de cuisson, d'une recette automatique ou de la fonction d'horloge, l'écran apparaît divisé en deux parties :

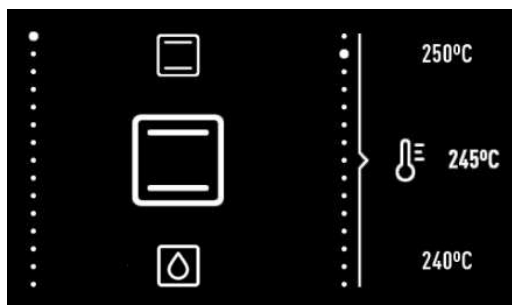

PARTIE GAUCHE.

Dans cette partie de l'écran se trouvent les fonctions de cuisson, les recettes automatiques ou les fonctions de programmation de l'horloge disponibles pour leur sélection.

Pour en sélectionner une, tournez la commande de gauche jusqu'à ce que la fonction souhaitée apparaisse en plus grand et validez la sélection avec la touche **OK** (si vous ne touchez à rien, le four valide la sélection automatiquement après quelques secondes).

PARTIE DROITE.

Dans cette partie de l'écran se trouvent les valeurs à régler en fonction du mode sélectionné : température, poids, durée, heure de fin, ...

Pour sélectionner une valeur, tournez la commande de droite jusqu'à ce que la valeur souhaitée apparaisse en plus grand et validez la sélection avec la touche **OK** (si vous ne touchez à rien, le four valide la sélection automatiquement après quelques secondes).

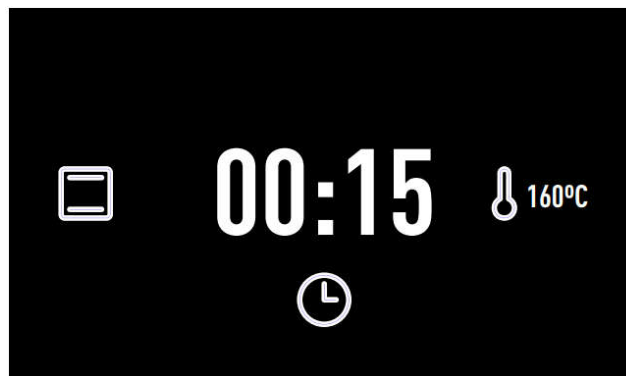
4.3. ÉCRAN DE CUISSON

Pendant la cuisson, des informations sur la situation du four apparaît à l'écran organisé chiffres autour du centre, en blanc, qui marqueront le temps:

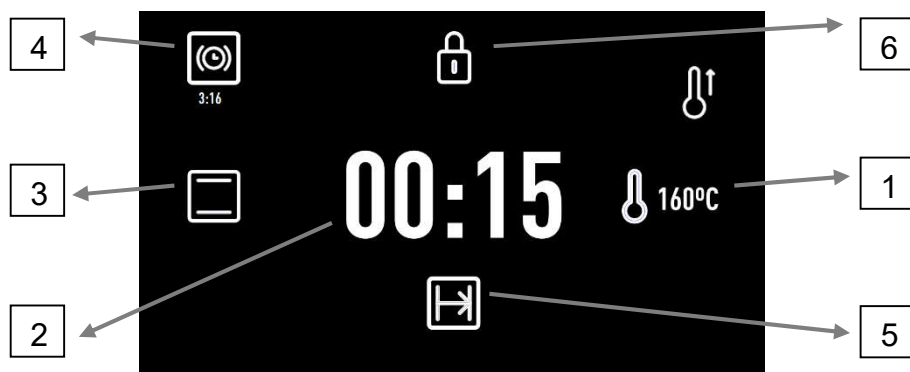
**1. Température sélectionnée.**

Le symbole  clignote en rouge jusqu'à ce que la température sélectionnée est atteinte et à condition que le four transmette de la chaleur à l'aliment.

2. Durée de cuisson.

Si vous n'avez pas programmé l'horloge, il indique le temps que le four a passé en pleine cuisson.

Si vous l'avez programmé, il indique le temps qu'il reste pour que la cuisson se termine (compte à rebours).

Si le four est programmé mais en attente (la cuisson n'a pas commencé), il indique le temps de cuisson total programmé

3. Fonction de cuisson ou recette automatique sélectionnée.

Si vous avez programmé des fonctions de temps, l'information relative à ces fonctions se trouve dans la partie droite de l'écran.

4.  **Avertisseur.** Compte à rebours pour la fin de l'alarme programmée.

5.  **Heure de fin**

Si vous avez activé les fonctions de sécurité, les informations concernant cette fonction s'affichent à l'écran.

 **Verrouillage du clavier.** S'illumine lorsque le verrouillage de sécurité pour les enfants est activé.

5. CUISSON AVEC DES FONCTIONS TRADITIONNELLES**5.1. FONCTIONS DU FOUR****INFORMATION**

Consultez le guide de cuisson fourni avec votre four pour connaître l'utilisation détaillée de chacune des fonctions.

**DÉCONNEXION****TRADITIONNELLE** **TRADITIONNELLE A TURBINE** **GRIL ET SOLE** **MAXI GRIL****GRIL****SOLE** **PIZZA** **TURBO** **CUISSON A FEUX****DOUX FERMENTATION DE PÂTES****DÉCONGÉLATION****MODE ECO****SCS (Steam Cleaning System by PANDO)****Fonctions intégrant un préchauffage rapide automatique**

5.2. POUR CUISINER AVEC LES FONCTIONS TRADITIONNELLES

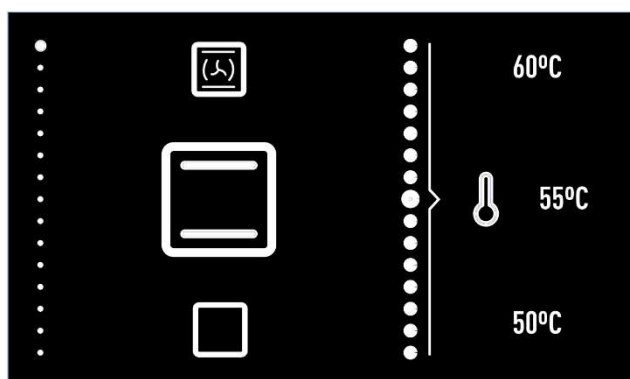

Sélecteur de fonction.

Allumez le four en appuyant sur la touche .

Tournez la commande de gauche jusqu'à ce que la fonction souhaitée apparaisse en plus grand.

La température recommandée pour la fonction choisie s'affiche ensuite à droite.

Si vous le souhaitez, vous pouvez modifier la température en tournant la commande de droite.

Validez la sélection avec la touche . Le four commence la cuisson.

À tout moment de la cuisson, vous pouvez :

- **Changer la fonction de cuisson**, en tournant la commande de gauche.
- **Modifier la température de cuisson** en tournant la commande de droite.
- **Programmer une alarme ou une durée/ heure de fin de cuisson**. En appuyant sur la touche .
- **Modifier la programmation des alarmes ou de la durée/heure de fin programmée**.

En appuyant sur la touche .



INFORMATION

Pour programmer ou modifier une programmation, consultez le paragraphe « Programmation de cuisson avec minuterie » que vous trouverez plus loin dans ce guide d'utilisation.

































5.3. PRÉCHAUFFAGE RAPIDE AUTOMATIQUE

Les fonctions indiquées intègrent un préchauffage rapide automatique

Pendant le préchauffage rapide, le symbole  s'allume.

Il est recommandé d'attendre que ce symbole s'éteigne avant d'introduire l'aliment.

6. CUISSON AVEC L'ASSISTANT PERSONNEL DE CUISSON (PANDO CHEF)**6.1. RECETTES AUTOMATIQUES DU FOUR**

VOLAILLES			POULET	
			CANARD	
			OIE	
			DINDE	
VIANDES			COCHON DE LAIT	
			BŒUF	
			AGNEAU	
			CÔTES	
POISSONS			COLIN	
			SAUMON	
PAINS			PAIN BLANC	
			PAIN NOIR	
			PAN COMPLET	
PIZZAS			PIZZA À PÂTE ÉPAISSE	
			PIZZA À PÂTE FINE	
DESSERTS			GÂTEAU EN MOULDE	
			GÂTEAU AUX FRUITS	
			PETIT GÂTEAU AUX FRUITS	
			GÂTEAU SUR PLAQUE	

 Recettes nécessitant le préchauffage du four à vide.

 Recettes pour lesquelles il faut retourner l'aliment.

6.2. POUR CUISINER AVEC L'ASSISTANT PERSONNEL DE CUISSON

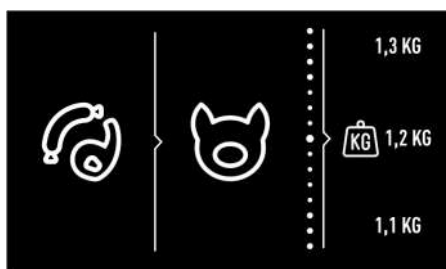

Sélection de la recette.

Tournez la commande de gauche jusqu'à ce que le type d'aliment que vous souhaitez cuisiner apparaisse en plus grand.

Dans la partie droite de l'écran, vous trouverez ensuite les recettes disponibles pour le type d'aliment sélectionné. Sélectionnez avec la commande de droite la recette souhaitée et validez la sélection avec la touche **OK**.

Dans la partie droite de l'écran, vous trouvez ensuite l'information dont le four a besoin pour programmer la cuisson.

Selon la recette sélectionnée, le four vous demande d'introduire :

POIDS DE L'ALIMENT : Sélectionnez avec la commande de droite et validez avec la touche **OK**.

TEMPÉRATURE : Validez la température proposée pour la recette ou sélectionnez-en une autre avec la commande de droite et validez avec la touche **OK**.

DEGRÉ DE FINITION : Vous pouvez sélectionner le degré de finition pour certaines cuissons :

- **ÉLEVÉ** : Bien cuit
- **MOYEN** : À point
- **FAIBLE** : Saignant

Une fois tous les paramètres sélectionnés, validez avec la touche **OK**.

Le four commence la cuisson et l'écran de sélection fait place à l'écran de cuisson sur lequel vous trouvez l'information suivante :

- La température de cuisson sélectionnée
- Le temps de cuisson restant
- La recette sélectionnée

Une fois la cuisson terminée, une alarme sonne pendant environ 90 secondes et le symbole de cuisson clignote sur l'écran. Appuyez sur n'importe quelle touche pour arrêter l'alarme.

Le four s'éteint automatiquement.



INFORMATION

Pendant les 10 premières minutes de cuisson, vous pouvez modifier le poids et le degré de finition ou programmer une heure de fin de cuisson.

Une fois ce temps écoulé, ces valeurs se fixent et ne pourront pas être modifiées.

Pour modifier ces valeurs de cuisson, appuyez sur la touche **⏸** et le four retourne sur l'écran de sélection.

À tout moment de la cuisson, vous pouvez :

Modifier la température de cuisson, en appuyant sur la touche. Validez avec la touche **OK**.

programmer une alarme. En appuyant sur la touche **⏸**.

Modifier la programmation d'une alarme programmée. En appuyant sur la touche **⏸**.

Pour programmer ou modifier une programmation, suivez les instructions du paragraphe «Programmation de cuisson avec minuterie» que vous trouverez plus loin dans ce guide d'utilisation.

6.3. PRÉCHAUFFAGE A VIDE





Les recettes présentes dans le tableau avec le symbole  requièrent l'introduction de l'aliment dans un four déjà chaud.

Lorsque vous sélectionnez une de ces recettes, le symbole  s'affiche à l'écran lorsque la cuisson commence. Lorsque le four atteint la température de cuisson, le symbole clignote et une alarme sonne pour vous avertir que vous pouvez introduire l'aliment.

L'alarme s'éteint automatiquement lorsque vous ouvrez la porte du four pour introduire l'aliment et le temps restant s'affiche sur l'écran de cuisson.

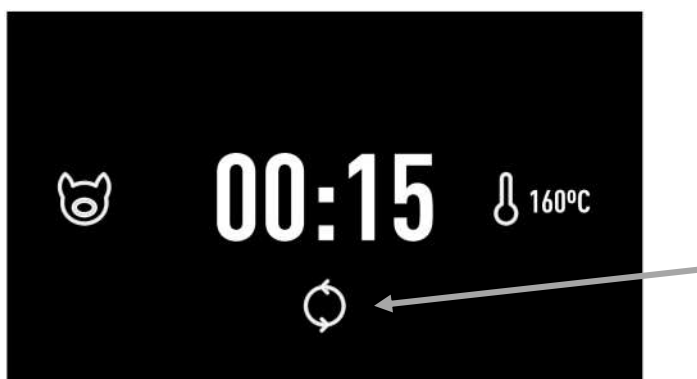
6.4. RETOURNER L'ALIMENT



Pour les recettes présentes dans le tableau avec le symbole , il faut retourner l'aliment pendant la cuisson.

Le four vous indique quand vous devez le faire avec une alarme sonore et le symbole  s'affiche sur l'écran de cuisson.

L'alarme s'éteint automatiquement lorsque vous ouvrez la porte du four pour retourner l'aliment.

7. PROGRAMMATION AVEC MINUTERIE DU FOUR



7.1. OPTIONS DE MINUTERIE

Pour programmer une cuisson, vous disposez des options de minuterie suivantes :

 **Avertisseur** : Une alarme sonne lorsque le temps de programmation est écoulé. La cuisson NE S'ARRÊTE PAS lorsque le temps est écoulé. Vous pouvez également programmer une alarme lorsque le four n'est pas en pleine cuisson.

INFORMATION

Vous pouvez programmer une alarme à tout moment, que le four soit en pleine cuisson ou non. Les autres options de minuterie sont disponibles uniquement lorsque le four est en pleine cuisson.



 **Durée de cuisson** : Permet de sélectionner le temps pendant lequel le four sera en pleine cuisson. Lorsque le temps programmé est écoulé, une alarme sonne, le symbole  clignote et le four cesse automatiquement de chauffer.

Appuyez sur n'importe quelle touche pour arrêter l'alarme et éteindre le four.

 **Heure de fin de cuisson** : Permet de sélectionner l'heure jusqu'à laquelle le four sera en pleine cuisson.

Lorsque l'heure programmée arrive, une alarme sonne, le symbole  clignote et le four cesse automatiquement de chauffer.

Appuyez sur n'importe quelle touche pour arrêter l'alarme et éteindre le four.

• **Début de cuisson différé ( Durée +  heure de fin de cuisson)** : Permet de programmer le four pour qu'il commence la cuisson automatiquement et s'éteigne également automatiquement une fois le temps de cuisson programmé écoulé.

INFORMATION

Pour programmer cette option, vous devrez programmer consécutivement la durée et l'heure de fin de cuisson.

Vous pouvez accéder aux options de programmation à tout moment d'une cuisson.

De même, vous pouvez accéder à la modification d'une programmation déjà établie.

10 secondes avant le début de la programmation, un bip sonore est entendu lequel vous pouvez annuler en appuyant sur n'importe quel bouton.

À la fin de la programmation, le bip sonore est aussi entendu, et vous pouvez annuler en appuyant sur n'importe quel bouton.

Si vous n'appuyez sur aucun bouton, le bip sonore cesse d'être entendu après 2 minutes.

INFORMATION

Si vous avez sélectionné une recette automatique, le four détermine automatiquement la durée de cuisson, c'est pourquoi cette option n'est pas disponible.

Dans ce cas, vous pouvez :

Programmer l'heure de fin de cuisson pendant les dix premières minutes de cuisson.

Programmer une alarme à tout moment.

7.2. POUR PROGRAMMER LES OPTIONS DE MINUTERIE

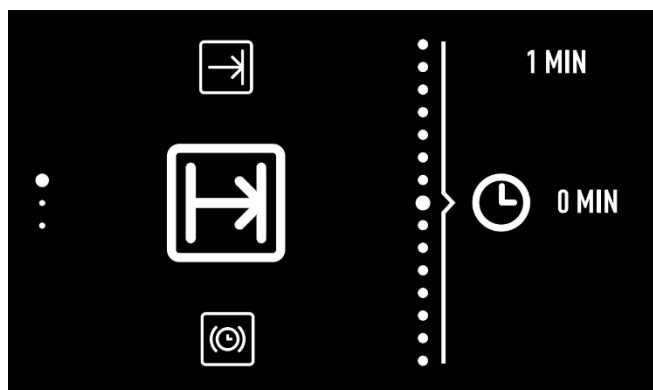

Programmation durée de cuisson.

1. Appuyez sur la touche  pour accéder au menu d'options de minuterie.
2. Tournez la commande de gauche pour sélectionner l'option de programmation souhaitée.
3. Tournez la commande de droite pour sélectionner la durée ou l'heure de fin selon l'option choisie.



INFORMATION

Le four n'autorise pas la sélection d'une heure de fin antérieure à l'heure actuelle.

Lorsqu'une heure de fin est programmée, l'heure actuelle est indiquée sur la partie centrale pour faciliter la sélection.



4. Validez la sélection avec la touche .
5. Ensuite, l'écran de cuisson réapparaît. Vous pourrez voir les minuteries programmées à droite du cercle central.



8. FONCTIONS DE SECURITE

8.1. VERROUILLAGE DE SÉCURITÉ POUR LES ENFANTS (verrouillage du panneau de contrôle)

Cette fonction peut être sélectionnée à tout moment pendant l'utilisation du four.

- **Avec le four éteint.** Le verrouillage pour les enfants empêche le four de s'allumer en appuyant sur la touche .
- **Pendant l'utilisation du four.** Si la fonction s'active alors que le four est en pleine cuisson ou en veille, la réponse du clavier se verrouille et les commandes ainsi que les valeurs de cuisson ne pourront pas être modifiées.

Pour activer la fonction, appuyez de façon prolongée sur la touche  jusqu'à ce qu'un bip sonore retentisse et que le symbole  s'affiche à l'écran. Le panneau de contrôle est verrouillé.

Pour désactiver la fonction, appuyez de nouveau de façon prolongée sur la touche  jusqu'à ce qu'un bip sonore retentisse et que le symbole  disparaisse.

9. FUNCTION SCS (Stem Clean System by PANDO)

Cette fonction facilite le nettoyage des traces de graisse et de saleté pouvant rester collées aux parois du four.

Pour un nettoyage plus efficace, évitez que la saleté ne s'accumule. Nettoyez régulièrement le four.

PROGRAMMER LA FONCTION SCS



MISE EN GARDE

Ne versez pas d'eau à l'intérieur du four chaud : cette opération peut endommager l'émail de votre four.

Effectuez systématiquement le cycle de nettoyage lorsque le four est froid. Si le cycle est lancé avec un four trop chaud, il est possible que le résultat ne soit pas celui attendu en plus d'endommager l'émail.

Retirez préalablement les plaques et tous les accessoires présents à l'intérieur du four, y compris les supports de plaques ou les rails télescopiques.

Pour ce faire, suivez les instructions figurant dans le manuel d'installation et d'entretien fourni avec votre four:

1. Lorsque le four est froid, placez un chiffon au fond de celui-ci.

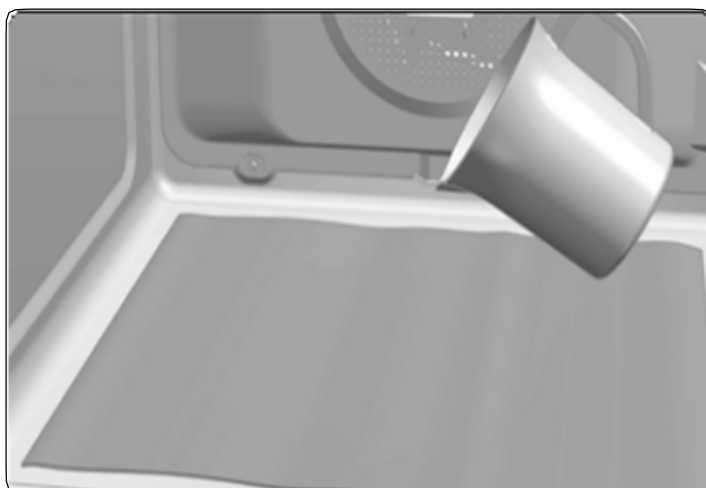



2. Versez lentement 200 ml d'eau dans la cavité inférieure du four.





INFORMATION

Pour un meilleur résultat, ajoutez une cuillère de liquide vaisselle doux dans le verre d'eau avant de le verser sur le chiffon.

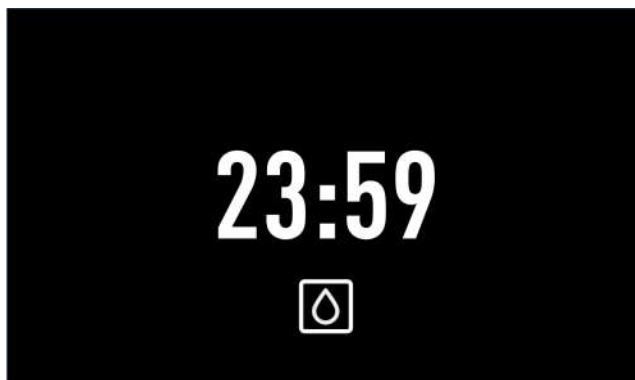
3. Allumez le four, tournez la commande de gauche pour sélectionner la fonction  et validez avec .
4. Un signal sonore est alors émis pour confirmer la mise en marche de la fonction SCS.
Sur l'écran, vous voyez le symbole  et le temps restant pour que la fonction s'achève.
La durée est pré réglée à 24 minutes.

**IMPORTANT**

La durée de cette fonction ne peut pas être modifiée. Pour terminer avant l'écoulement total de cette durée, Eteignez le four en appuyant sur la touche .

5. À l'heure de fin de cycle, le four s'éteint, un signal sonore retentit et le symbole  se met à clignoter rapidement.

**IMPORTANT**

Maintenez la porte du four fermée jusqu'à la fin de la fonction SCS.

La phase de refroidissement est nécessaire au bon déroulement de cette dernière.

6. Appuyez sur n'importe quelle touche pour couper le signal sonore et éteindre le symbole .
7. Le four s'éteint automatiquement.
8. Le four est prêt pour retirer les restes de saleté et l'excès d'eau avec le chiffon a.

La fonction SCS est réalisée à basse température. Les durées de refroidissement peuvent néanmoins varier en fonction de la température ambiante.

**MISE EN GARDE**

Avant de toucher directement la surface intérieure du four, veillez à ce que la température soit appropriée.



Si un nettoyage en profondeur s'avère nécessaire après l'utilisation de la fonction SCS, utilisez des détergents neutres et des éponges douces non abrasives.

10. MODE DEMO (Fonction spéciale pour les expositions)

Lorsque le mode DEMO est activé, le four peut être utilisé sans qu'il ne chauffe.

Il est recommandé d'activer ce mode si le four va être installé dans une exposition tout en étant branché au secteur.

Activation du mode DÉMO

Avant de mettre l'horloge à l'heure, appuyez simultanément sur les touches  et  , jusqu'à ce que l'indication «DEMO Mode ON» s'affiche à l'écran.

Mettez ensuite le four à l'heure.

Le mot «DEMO» reste affiché à l'écran et le four peut fonctionner normalement. Cependant, il ne chauffera pas.

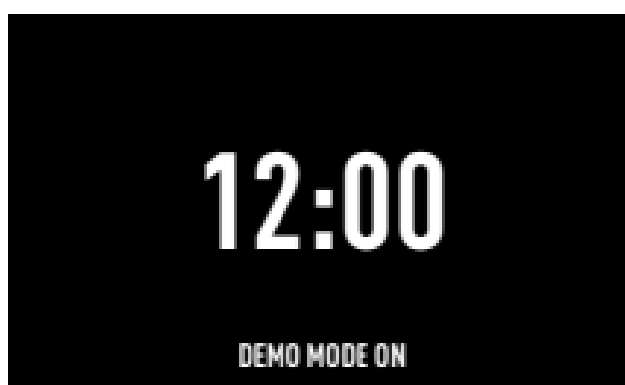

Pour désactiver le mode DÉMO, vous devez débrancher le four du secteur.

11. SPÉCIFICATIONS TECHNIQUES

INSTALLATION	PHT-941	PHT-963
Tension (V)	220-240	220-240
Frequence (Hz)	50/60	50/60
Câble Alimentation (m)	1,1 m SANS FICHE	1,1 m SANS FICHE
Dimensions Encastre (Haut x large x fond) (mm)	450-460 x 560-568 x 580	590-600 x 560-568 x 580
Dimensions du produit sans panneau avant (Haut x large x fond) (mm)	430x545x537	570x545x537
LOGISTIQUE / EMBALLAGE		
Poids Net (Kg)	25	32
Poids Brut (Four+Emballage) (Kg)	27	34
Dimensions Emballage (Haut x large x fond) (mm)	510x635x655	650x635x655
ACCESOIRES		
Manuel Instruccions - Idiomes (2)	ES/PT/UK/FR/GE	ES/PT/UK/FR/GE
Plateau Plat 30	1	1
Plateau Profonde 50	1	1
Grill renforcé	1	1
AVANTAGES		
Volum Utile (1) (L)	44	70
Volum Interieur Global (1) (L)	45	71
Surface de cuisson utile (1) (cm2)	1280	1280
Écart de température	30-270 °C	30-270 °C
VALEURS DE PUISSANCE ÉLECTRIQUE		
RESISTENCES		
Grill + Voûte	1.400 W +1.100 W	1.400 W +1.100 W
Inférieure	1.150 W	1.150 W
Circulaire	1800	2000
Moteur Turbo	22	22
Moteur Réfrigération	18 W	18 W
Puissance d'éclairage	25 W	25 W
ILUMINACIÓN		
LUMIÈRE INTÉRIEURE	HALOGEN	HALOGEN
FONCTION DE PUISSANCE MAXIMALE	Bottom + TURBO (Pizza)	Bottom + TURBO (Pizza)
Puissance maximale du four (230 V)	3015 W	3215 W
CONSOMMATION D'ÉNERGIE (1) (3) - FICHE PRODUIT		
Fonction plus efficace	ECO	ECO
Indice d'efficacité énergétique (EEI)	80,8	81
Classe d'efficacité énergétique	A+	A+
MARQUES ET CERTIFICATS	CE / N / CCA / CB / EAC / G - Mark	CE / N / CCA / CB / G - Mark

12. SCHÉMAS ET DIMENSIONS D'INSTALLATION

PHT 941

INSTALLATION EN COLONNE

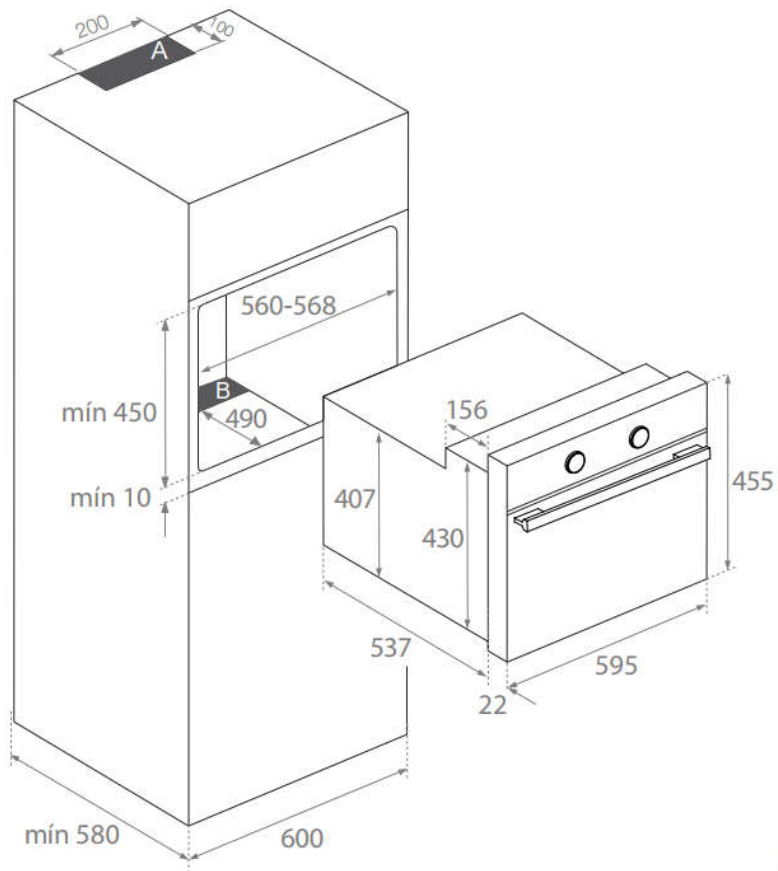
 **REMARQUE**

Respectez les trous de ventilation du meuble, voir les plans d'installation (200x100mm en zone **A** et 560x90mm en zone **B**). Si ces événements ne sont pas disponibles, le produit ne fonctionnera pas correctement et peut subir des dommages qui ne seraient PAS couverts par la garantie.

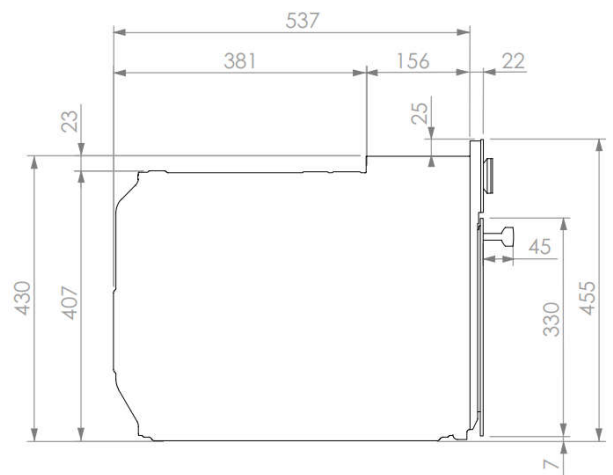

INSTALLATION SOUS PLAN DE TRAVAIL

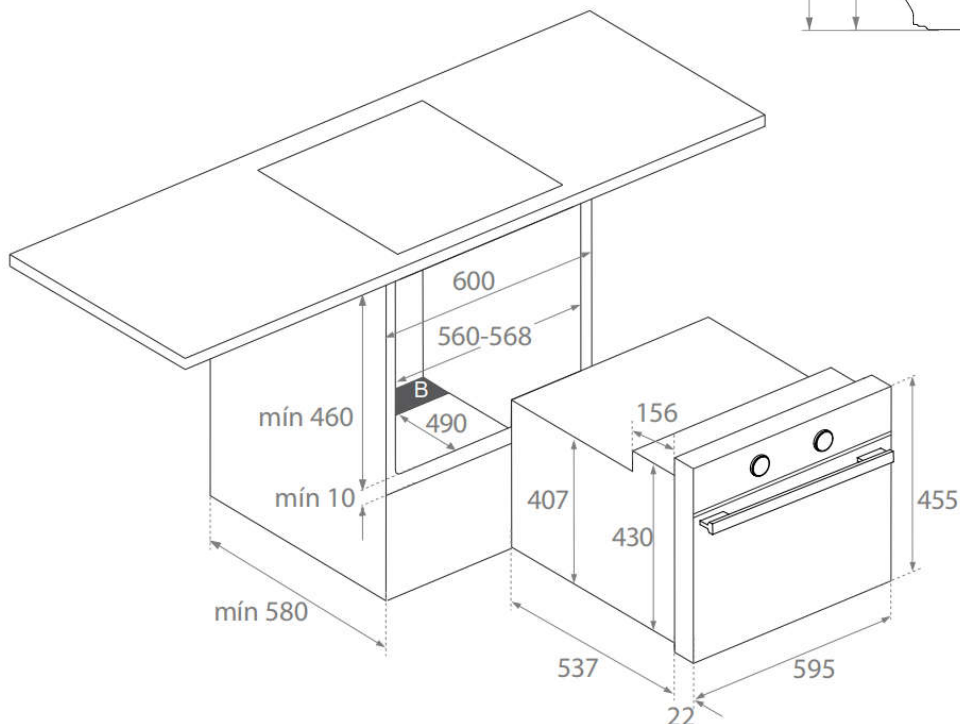

13. SERVICE TECHNIQUE APRÈS-VENTE (SAT) ET GARANTIE

INOXPAN S.L., vous remercie pour choisir un produit PANDO et pour la confiance déposée en notre marque qui se distingue par sa qualité, son design et son innovation en restant fidèle à ses origines et ses engagements.

CONDITIONS DE GARANTIE PANDO:

Cet appareil dispose d'une garantie de 3 ans à partir de la date d'achat et le couvre contre tout défaut de fabrication qu'affecte son bon fonctionnement. Pour activer cette garantie il est indispensable de présenter la facture d'achat auprès du technicien du Service Officiel Autorisé Pando.

Durant cette période, l'Entreprise s'engage à remplacer ou réparer gratuitement toutes les pièces défectueuses dû à un vice ou défaut de fabrication de l'appareil, jusqu'à obtenir son bon fonctionnement, ainsi que la main d'œuvre nécessaire et les frais occasionnés comme conséquence de sa réparation ou de son remplacement.

EXCLUSIONS DE LA GARANTIE PANDO:

- Les points suivants ne sont pas couverts par la garantie, et pourraient être cause d'annulation de cette dernière, impliquant que le l'utilisateur soit dans l'obligation de prendre à sa charge les frais concernant la main d'œuvre, les pièces et le déplacement du service technique:
- Révision de l'installation ou de son fonctionnement, nettoyage ou maintenance.
- Si l'installation de l'appareil n'a pas été effectuée par du personnel spécialisé agréé ou par le personnel du service technique officiel de Pando, qui satisfont aux exigences des normes de sécurité et des réglementations relatives à l'alimentation électrique.
- Dans le cas d'un usage à fin professionnelle ou NON domestique, pour lequel il est prévu.
- Mauvais fonctionnement de l'appareil dû à un non-respect des normes, instructions et recommandations indiquées dans les manuels d'utilisation de l'appareil.
- Dysfonctionnements ou problèmes causés par une installation inadéquate, ou par le fait de ne pas avoir les espaces libres nécessaires dans le mobilier et indiqués dans le manuel d'installation, pour une ventilation adéquate du produit.
- Pannes ou imperfections produites par le transport ou déplacements, manipulations des appareils par personnel non autorisé ou tiers à l'entreprise et/ou marque PANDO.
- Coups, renforcements, rayures, frottements, verres brisés ou rayés.
- Présence de corps étranger sans lien avec l'appareil, à l'intérieur ou extérieur de celui-ci.
- Dans le cas que le technicien n'a pas un accès facile au produit, car il y a des éléments qui empêchent son accès facile et sûr. Les moyens nécessaires à mettre en œuvre pour que le technicien Autorisé Pando puisse y accéder selon les conditions spécifiées ci-dessus seront à la charge de l'utilisateur.
- Manipulation non conforme du câblage extérieur.
- Les composants esthétiques et d'utilisation tels que des écrans lumineux, des lampes, des plateaux, des grils, des guides.
- Rouille, brûlures, taches ou changements de couleur dans le châssis, la porte, les accessoires ou la cavité intérieure causés par un entretien ou une utilisation inappropriés, ou par une application incorrecte ou une exposition non protégée à des éléments corrosifs tels que des produits de nettoyage non recommandés par le fabricant et inappropriés.
- Pannes et imperfections produites par des variations du réseau électrique, ou bien dû à des causes naturelles imprévisibles telles que celles d'origine atmosphérique ou géologique comme les tempêtes, éclairs, tremblement de terre, inondations, ...
- Les appareils procédant de la revente, deuxième main, changement du titulaire original de l'appareil ou venant d'exposition qui ont plus de 2 ans depuis leur date de fabrication.

INOXPAN, S.L., Est expressément exclu de toute responsabilité concernant d'éventuels dommages directs ou indirects infligés à des personnes ou des biens, venant d'une utilisation non-conforme de l'appareil.

Information de contact du Service Technique Officiel Autorisé Pando:

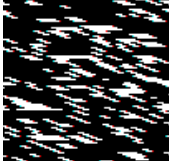
ESPAÑA, PORTUGAL Y ANDORRA:	OTROS PAÍSES:
<p>ES www.pando.es/asistencia-tecnica/</p> 	<p>EN https://www.pando.es/en/after-sales-services/</p> <p>FR https://www.pando.es/fr/service-apres-vente/</p> 

First of all we wish to thank you for the trust shown on our Company by purchasing one of our products. We are sure you have made the right choice.

In Pando, not only we offer first quality products, but also we make available a large professional team to serve and assist you on any query you may have regarding installation and/or performance.

We also suggest you to pay a visit to our web site (www.pando.es/en) to get to know us better and where you will find all product range containing all necessary commercial and technical information.

A wide selection of extractor hoods can be found there; Wall Hoods, Ceiling, Island or Canopy Hoods. Four types of installation making possible to adapt ourselves to any type of kitchen based on different needs.

At the same time, we take the opportunity to introduce you our collection of in house essential appliances, such our new high performance Ovens and Microwaves, Induction and Gas Hobs to make real your best recipes. Wine Coolers and Aging Wine Coolers to maintain and keep your wines in best of conditions and built-in Dishwashers with latest technology.

All that under a brand with over 40 year history in the market, making products like a real craftsman, and gathering in them the best of our experience to please all your needs.

We sincerely look forward you to have fun, experience and enjoy with the comfort and capacity of what already became your new kitchen ally.

Many Thanks

The PANDO Team

1. DESCRIPTION OF THE OVE	5
2. CONTROL PANEL	5
3. SWITCHING ON AND SETTING THE TIME	6
4. DESCRIPTION OF THE CONTROL PANE	7
4.1. Start screen / standby.....	7
4.2. Selection screen	8
4.3. Cooking information scree.....	9
5. TRADITIONAL COOKING FUNCTION	10
5.1. Oven functions.....	10
5.2. Cooking with traditional functions	11
5.3. Automatic fast preheating	11
6. COOKING WITH THE PERSONAL COOKING ASSISTANT (PANDO CHEF)	12
6.1. Automatic oven recipes	12
6.2. Cooking with the personal cooking assistant.....	13
6.3. Preheating while empty.....	14
6.4. Turning food.....	14
7. OVEN TIMER SETTINGS	15
7.1. Timer options.....	15
7.2. Programming the timer option.....	16
8. SAFETY INSTRUCTIONS	17
8.1. Child safety lock (control panel lock)	17
9. FUNCTION SCS (STEM CLEAN SYSTEM BY PANDO)	18
10. DEMO MODE (SPECIAL FUNCTION FOR SHOP FLOORS)	20
11. TECHNICAL SPECIFICATIONS	21
12. INSTALLATION DIAGRAMS AND DIMENSIONS	22
13. AFTER-SALES SERVICE AND GUARANTEE:	24

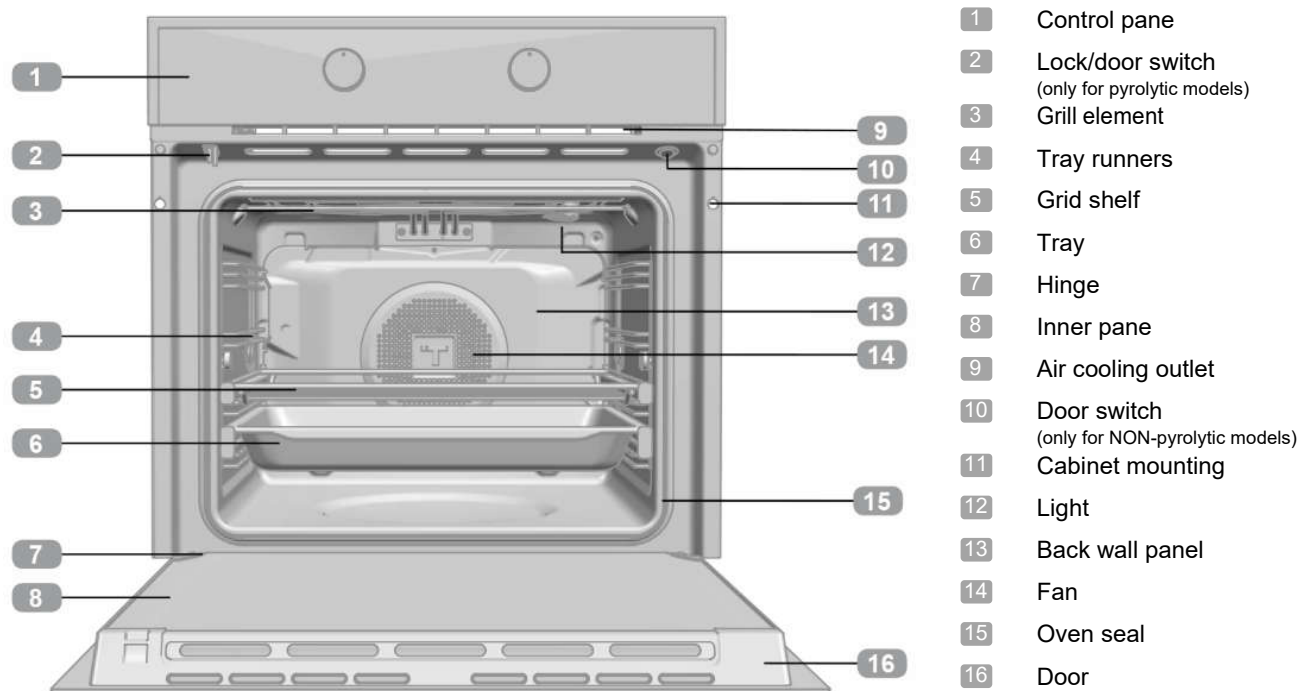
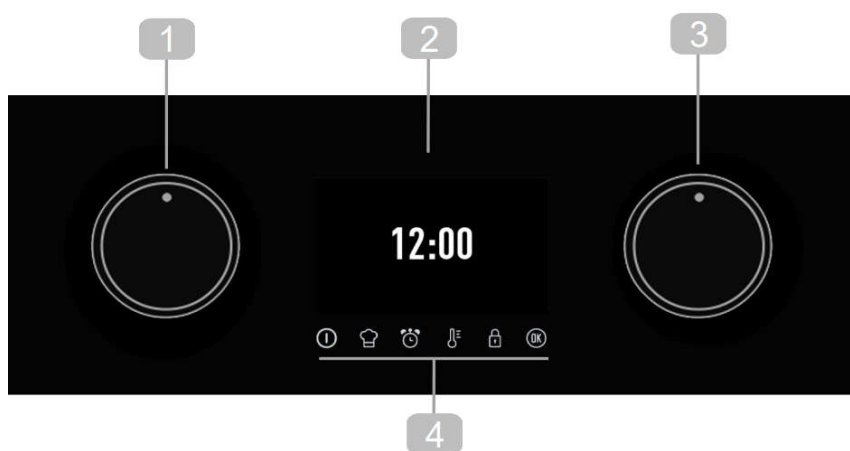
1. DESCRIPTION OF THE OVE**2. CONTROL PANEL**

- 1 Dial to scroll through the menus on the left side of the screen. Cooking mode dial.
- 2 Display screen.
- 3 Dial to scroll through the menus on the right side of the screen. Cooking settings dial.
- 4 Keys.

① **Switching the oven ON/OFF.**

🌡️ **Altering the oven temperature.**

👨‍🍳 **Access to the personal Cooking assistant (PANDO CHEF)**

🔒 **Activation / Deactivation of the Keypad / door lock depending on the model.**

🕒 **Access to the timing and programming settings.**



Ⓞ **Confirm button. Switching the inner light on/off.**

3. SWITCHING ON AND SETTING THE TIME

When plugging the oven in for the first time, the logo will appear followed by 12:00 flashing on the screen.

You must set the time in order to use the oven.

SETTING THE TIME:

- Select hours with the left knob and minutes with the right knob. Validate the selection with the key  or wait a few seconds.
- Select with the right control the type of graphic for the hour display.
- Validate the selection with the key  or wait a few seconds.

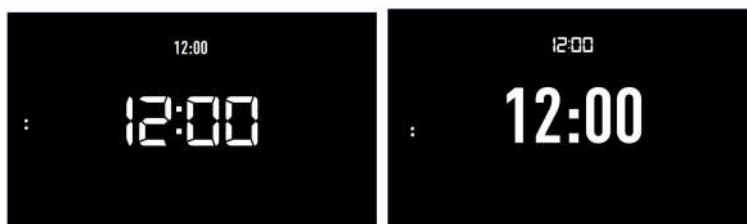

An audible signal will be heard confirming that the time has been set on the screen.

To change the time:

With the oven in standby (start screen), hold the  button until the time begins to flash. Follow these steps to change the time.



WARNING

The sensitivity of the touch controls continuously adapt to the ambient conditions. Make sure the glass surface of the control panel is clean and free of any obstacles when plugging in the oven.

If the clock does not respond correctly when you touch the glass, unplug the oven for a few seconds and then plug it in again. Doing this causes the sensors to adjust automatically and they will react again to finger touch.



WARNING

In the event of a power failure, your electronic clock/timer settings will be erased.

The time 12:00 will appear.

You can set the time as described above.

If the oven door was locked before the power cut, the locked symbol will appear until it is unlocked.

This may take several minutes, depending on the temperature inside the oven, and during this period you cannot reset the time.

Once the door is unlocked you can set the time as described above.

4. DESCRIPTION OF THE CONTROL PANE

Information that you will find on the display screen of your oven and how this will be displayed is outlined below.

4.1. START SCREEN / STANDBY

This screen will appear when the oven is not working, but is still plugged in.

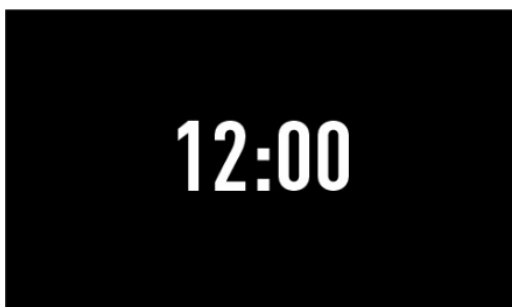

If the keypad lock are activated, the  symbol will appear on the top of the screen.

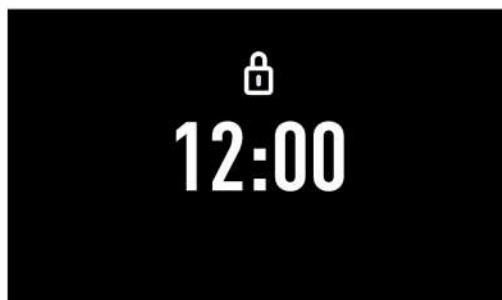

If a timer has been programmed, the screen will stop showing the time and show a countdown, as can be seen in the image.

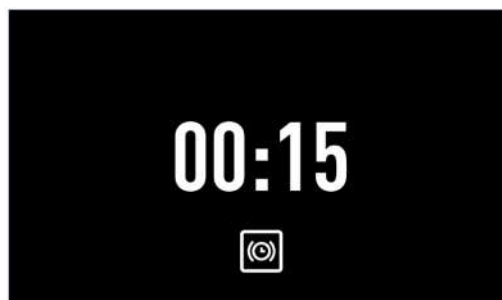

4.2. SELECTION SCREEN

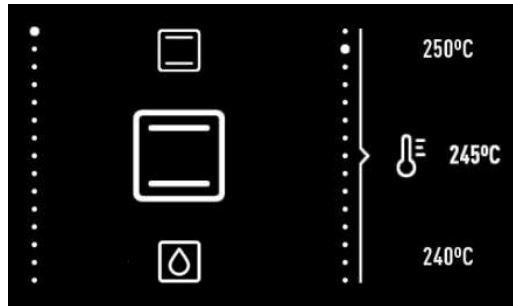

FUNCTION SELECTION:

- Start the unit using the power button 

When selecting a cooking function, automatic recipe or timer programme the screen will be split into two sections:

LEFT SECTION.

This part of the screen shows available cooking settings, automatic recipes and timer programmes. To select any one of these, turn the left dial until the desired function appears and confirm the selection with the button  (if you do not press any buttons, the oven will confirm this automatically after a few seconds).

RIGHT SECTION.

This part of the screen shows the values that can be set according to the selected mode: temperature, weight, duration, finish time...

To select a value, turn the right dial until the desired value appears and confirm the selection with the button  (if you do not press any buttons, the oven will confirm this automatically after a few seconds).

4.3. COOKING INFORMATION SCREE

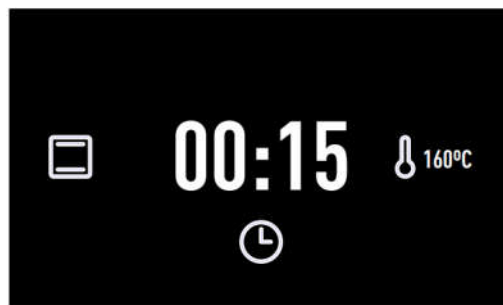

During cooking, the information on the oven's status will appear on the screen around two central circles:

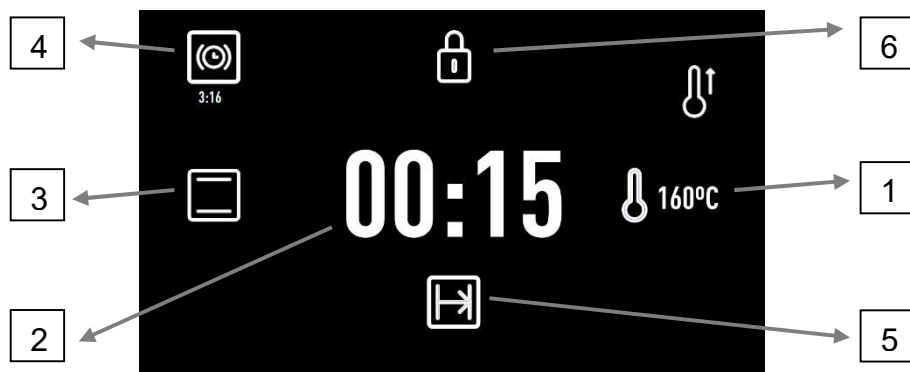

1. Selected temperature.

The symbol  will flash red until the selected temperature is reached and whenever the oven is transmitting heat to the food. When the selected temperature is reached, this symbol will turn off, leaving only the blue indicator.

2. Cooking time.

If the timer has not been programmed, the elapsed cooking time will be shown.

If the timer has been set, the time left until cooking ends (countdown) will be shown.

If the oven has been programmed, but is set to delay (cooking has not yet started), the total programmed cooking time will be shown.

3. Cooking settings or automatic recipe selection.

If time settings have been programmed, information relevant to these is shown on the right side of the screen.

4.  **Timer.** Countdown with audible signal to indicate the cooking time has finished.

5.  **Finish time.**

If you have activated security functions, the information regarding this function is displayed on the screen.

6.  **Keypad lock.** The child-safety lock will light up when activated.

5. TRADITIONAL COOKING FUNCTION**5.1. OVEN FUNCTIONS****INFORMATION**

For a description of the use of each of these functions, please consult the cooking guide included with your oven.

**ON / OFF BUTTON****CONVENTIONAL** **CONVENTIONAL WITH FAN** **GRILL AND BOTTOM HEAT** **MAXIGRILL****GRILL****BOTTOM HEAT** **PIZZA** **TURBO** **SLOW COOKING****RISING DOUGH****DEFROSTING****ECO****SCS (STEAM CLEANING SYSTEM BY PANDO)****Settings with fast preheating**

5.2. COOKING WITH TRADITIONAL FUNCTIONS

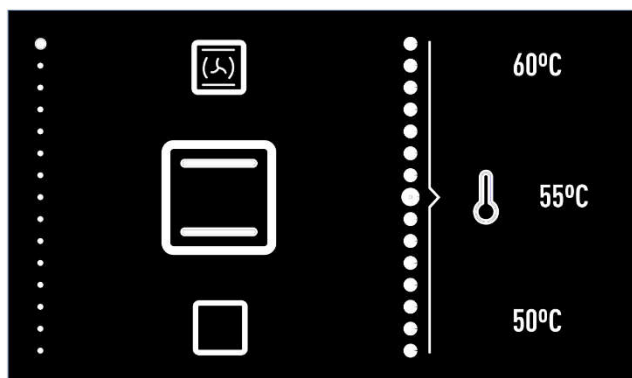

Selecting functions.

Turn the oven on by pressing the button .



Turn the left dial until the desired function has been reached.

The recommended temperature for the function chosen will then appear on the right.

If desired, the temperature can be changed by turning the right dial.

Confirm your choice with the  button. The oven will begin cooking.

At any time during the cooking process you can:

- **Change the cooking function** by turning the left dial.
- **Change the cooking temperature** by turning the right dial.
- **Programme the cooking timer or a duration/finish time** by pressing the  button.
- **Modify programmed timers or duration/finish times** by pressing the  button



INFORMATION

To set or modify a programme, consult the “Timed cooking programmes” section which can be found further on in this user manual.



























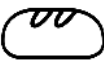





5.3. AUTOMATIC FAST PREHEATING

The functions indicated incorporate fast preheating.

During fast preheating the  symbol lights up.

We recommend waiting until this symbol goes away before putting in the food.

6. COOKING WITH THE PERSONAL COOKING ASSISTANT (PANDO CHEF)**6.1. AUTOMATIC OVEN RECIPES**

POULTRY			CHIKEN	
			DUCK	
			GOOSE	
			TURKEY	
MEAT			SUCKLING PIG	
			BEEF	
			LAMB	
			CHOPS	
FISH			HAKE	
			SALMON	
BREAD			WHITE BREAD	
			BROWN BREAD	
			WHOLEMEAL BREAD	
PIZZA			THICK CRUST	
			THIN CRUST	
DESSERTS			CAKES IN A MOULD	
			LARGE FRUITCAKE	
			SMALL PIE	
			CAKES ON TRAYS	

 Recipes that require preheating the oven while empty.

 Recipes that require turning the food.

6.2. COOKING WITH THE PERSONAL COOKING ASSISTANT

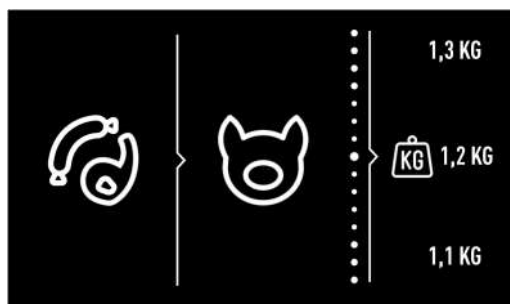

Recipe selection.

Turn the left dial until the type of food that you want to cook is shown.

Available recipes for the selected food type will appear on the left side of the screen. With the right dial select the desired recipe and confirm it with the **OK** button.

Then, on the right section of the screen, the information that the oven needs to programme the cooking will appear.

Depending on the recipe selected, the oven will ask you to key in:

THE WEIGHT OF THE FOOD: Select with the right dial and confirm with the **OK** button.

THE TEMPERATURE: Confirm the suggested temperature for the recipe or select another with the right dial and confirm with the **OK** button.

LEVEL OF BROWNNESS: For some recipes, you can select the finish:

- **HIGH:** Well browned
- **MEDIUM:** Medium browned
- **LOW:** Lightly browned

When all settings have been chosen, confirm with the **OK** button.

The oven will start cooking and the cooking screen will appear in place of the selection screen, showing the following information:

- Selected cooking temperature
- Remaining cooking time
- Recipe selected

When the cooking time has finished an audible signal will sound for approximately 90 seconds and the cooking symbol will flash on the screen. Press any button to turn off the audible signal.

The oven will turn off automatically.



INFORMATION

In the first 10 minutes of cooking, you will be able to change the weight and level of brownness, or set a finish time.

After this time, these settings will be set and cannot be changed.

To change these cooking settings, tap the button  and the oven will revert to the selection screen. Follow the instructions above.

At any time during the cooking process you can:

Change the cooking temperature by touching the button . Confirm with the **OK** button.

set the timer by pressing the **+** button.

Change the existing timer by pressing the **-** button.

To set or modify a programme, consult the “Timed cooking programmes” section which can be found further on in this user manual.

6.3. PREHEATING WHILE EMPTY

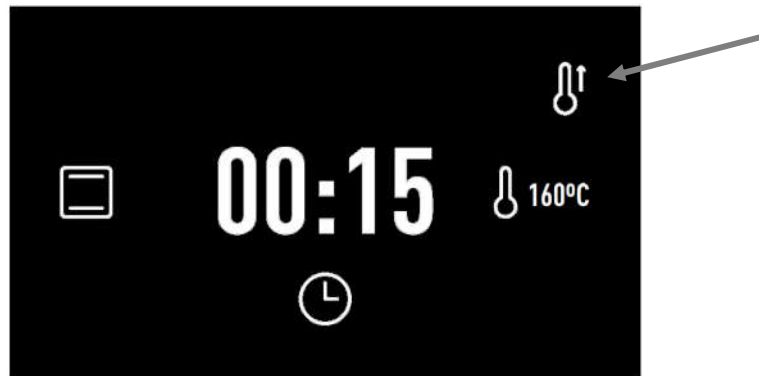

For recipes indicated in the table by the symbol , the oven must be preheated before any food is put in.

When you select one of these recipes, the  symbol will appear on the screen as cooking begins. When the oven reaches the cooking temperature, the symbol will flash and an audible signal will sound to notify you that the food can now be put into the oven.

When the door is opened to put in the food the audible signal will switch off automatically, and the remaining time will show on the cooking screen.

6.4. TURNING FOOD

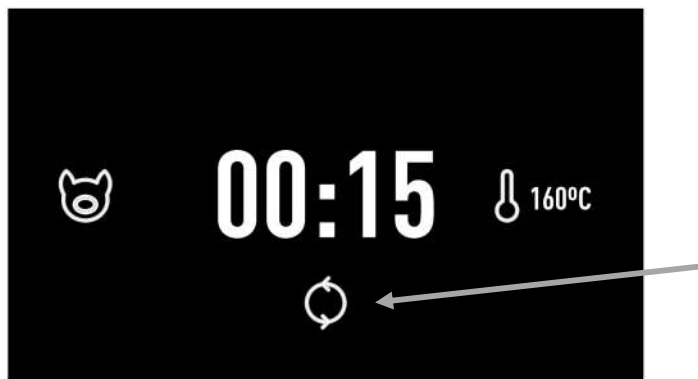

For recipes indicated in the table by the symbol , food must be turned during cooking.

The oven will notify you when to do this with an audible signal and the  symbol will appear on the cooking screen.

Opening the oven door to turn the food will cause the audible signal to turn off automatically.

7. OVEN TIMER SETTINGS

7.1. TIMER OPTIONS

You can use the following timer options to programme cooking:

 **timer:** An audible signal will sound when the programmed time finishes. Cooking will NOT stop when the timer sounds. The timer can also be set when the oven is not cooking.



INFORMATION

You can set a timer at any time regardless of whether or not the oven is cooking.

The rest of the timer options are available only when the oven is cooking.



Cooking time: Allows you to select for how long the oven will cook.

An audible signal will sound at the end of the programmed time, the  symbol will flash and the oven will stop heating automatically.



Tap any button to stop the audible signal and turn the oven off.



Cooking Finish time: Allows you to set the time for when the oven will stop cooking.

An audible signal will sound when the set time is reached, the  symbol will flash and the oven will stop heating automatically.

Tap any button to stop the audible signal and turn the oven off.

- **Starting delayed cooking ( Cooking Duration +  Finish time):**
Allows you to programme the oven to start cooking automatically and switch off automatically once the programmed time has ended.



INFORMACIÓN

To programme this option, set the Cooking Duration and Finish Time consecutively.

You can access the programming options at any time during cooking.

Similarly, you can change an existing programme.

10 seconds before the programmed timing begins, an audible beep will sound, which you can cancel by pressing any button.

At the end of programming, the audible beep is heard again, which you can cancel by pressing any button.

If you do not press a button, the audible beep stops being heard after 2 minutes.



INFORMATION

If you have chosen an automatic recipe, the oven will automatically determine the cooking time so this option will not be available.

However, you can:

Programme the Finish Time during the first ten minutes of cooking.

Set the timer at any time.

7.2. PROGRAMMING THE TIMER OPTION

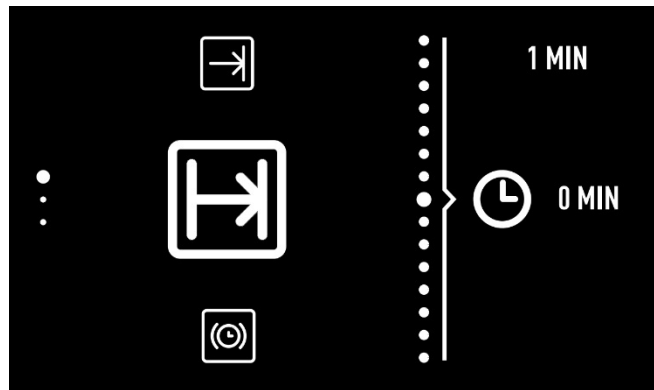

Programming during cooking.

1. Press the  button to access the timer options menu.
2. Turn the left dial to select the desired programme option.
3. Turn the right dial to choose the duration or finish time depending on the chosen option.



INFORMATION

The oven will not allow you to select a finish time before the time it is now.

When programming a finish time, the centre section will show the current time to help you choose.



4. Confirm your choice with the  button.
5. The cooking screen will then be shown again. You will be able to see programmed timers to the right of the central circle.



8. SAFETY INSTRUCTIONS

8.1. CHILD SAFETY LOCK (CONTROL PANEL LOCK)

This feature can be activated at any time:

- **With the oven switched off.** The child lock will not allow the oven to be switched on when the button is touched .
- **With the oven in use.** If the feature is activated while the oven is cooking or set to delay, the keypad will not respond and it will not be possible to use the dials or change the cooking settings.

To activate this feature, press and hold the  button until you hear a beep and the symbol  appears on the screen. The control panel is now locked.

To deactivate this feature, touch and hold the button  again until you hear a beep and the symbol  disappears.

9. FUNCTION SCS (STEM CLEAN SYSTEM BY PANDO)

This feature helps to clean any grease and other deposits from the sides of the oven. Avoid letting deposits build up to make cleaning easier. Clean the oven often.

PROGRAMING THE SCS FUNCTION

WARNING

Do not pour water into the hot oven as this can damage the enamel.

Always run the cycle when the oven is cold. Results may be affected if you do so while the oven is too hot and in addition can damage the enamel.

First remove the trays and all accessories from inside the oven, including the tray runners and telescopic guide rails to clean these, follow the instructions in the installation and Maintenance booklet that comes with your oven.

To do this, follow the instructions below:

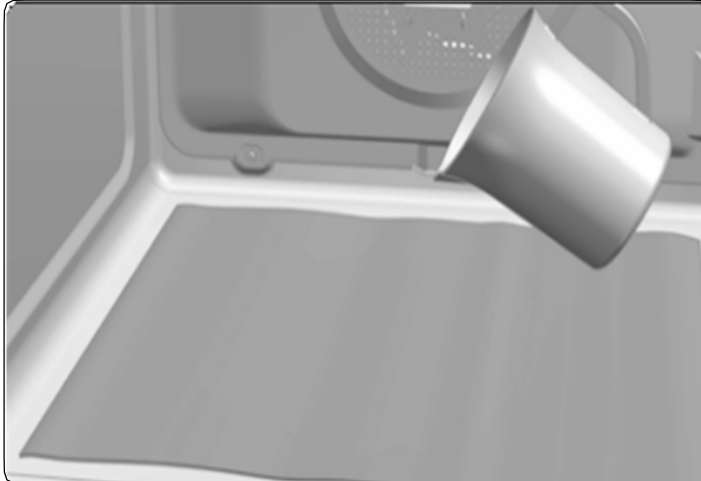

1. With the oven cold, spread a cloth on the bottom of the oven.



2. Slowly pour 200 ml of water onto the bottom of the oven.

INFORMATION

For best results, add a teaspoon of mild washing-up detergent to a glass of water before pouring it onto a cloth.

3. Switch the oven on, turning the left dial to select the  function and confirm with the  button
4. An audible signal will be heard confirming that the SCS feature has been activated.

On the screen the  symbol will appear as will the remaining time the cycle needs to finish.
The duration time is pre-set to 24 minutes.

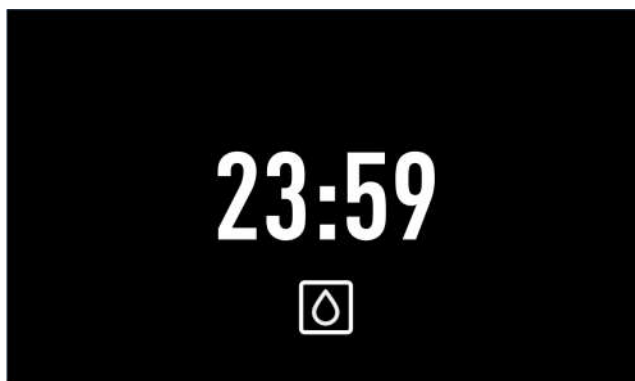
**IMPORTANT**

The duration of this cycle cannot be changed. To stop before the completion of the cycle, turn the oven off by pressing the button .

5. When the cycle ends, the oven will turn itself off, an audible signal will sound and the  symbol will flash quickly.

**IMPORTANT**

Do not open the oven door until the SCS cycle has ended completely.
The cooling cycle is necessary for this feature to work properly.

6. Press any button with your fingertip to stop the audible signal and to turn off the  symbol.
7. The oven will turn off automatically.
8. The oven is ready for dirt deposits and excess water to be removed with the cloth.

The SCS feature works at low temperatures. However, cooling times can vary according to room temperature.

**WARNING**



Before touching the inner surface of the oven directly, make sure that the temperature is not too hot.

If a deeper clean is required after running the SCS feature, use neutral detergents and non-abrasive sponges.

10. DEMO MODE (SPECIAL FUNCTION FOR SHOP FLOORS)

With the DEMO mode activated, you can control the oven without heating. Activating this mode is recommended if the oven is to be plugged in at a showroom.

Activating DEMO mode

Before setting the clock, press the buttons   simultaneously until "DEMO Mode ON" appears on the screen.

Then, set the time on the oven.

The word "DEMO" will be shown permanently on the panel and the oven will work as normal, but without heating up.

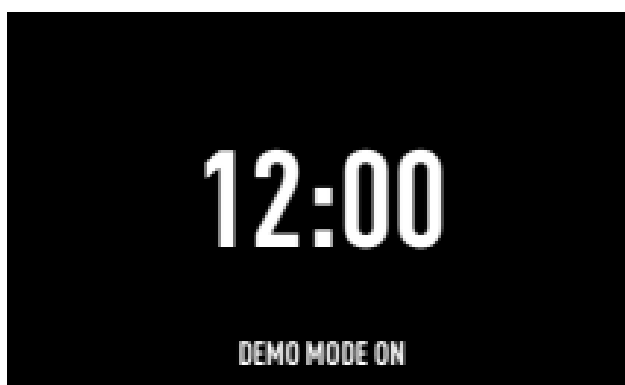

To deactivate DEMO mode, unplug the oven from the socket.

11. TECHNICAL SPECIFICATIONS

INSTALATION	PHT-941	PHT-963
Voltage (V)	220-240	220-240
Frequency (Hz)	50/60	50/60
Connecting Wire (m)	1,1 m WITHOUT PLUG	1,1 m WITHOUT PLUG
Built-in Dimensions (High x Wide x Bottom) (mm)	450-460 x 560-568 x 580	590-600 x 560-568 x 580
Product Dimensions without front panel (High x Wide x Bottom) (mm)	430x545x537	570x545x537
LOGISTIC / PACKING INFORMATION		
Net Weight (Kg)	25	32
Gross Weight (Oven+Pack.) (Kg)	27	34
Packaging Size (High x Wide x Bottom) (mm)	510x635x655	650x635x655
ACCESSORIES		
Instruction Book - Languages (5)	ES/PT/UK/FR/GE	ES/PT/UK/FR/GE
Flat Tray 30	1	1
Deep Tray 50	1	1
Reinforced Grid	1	1
FEATURES		
Net Cavity Volume (1) (L)	44	70
Overall Cavity Volume (1) (L)	45	71
Usable Cooking Surface (1) (cm2)	1280	1280
Thermostat Temperature Range	30-270 °C	30-270 °C
ELECTRICAL POWER DATA		
HEATING ELEMENTS		
Grill + Top	1.400 W +1.100 W	1.400 W +1.100 W
Bottom	1.150 W	1.150 W
Rear	1800	2000
Turbo Fan Motor	22	22
Cooling Fan Motor	18 W	18 W
Light Power Lamp	25 W	25 W
LIGHT		
INSIDE LIGHT	HALOGEN	HALOGEN
MAXIMUN POWER FUNCTION	Bottom + TURBO (Pizza)	Bottom + TURBO (Pizza)
Maximun Oven power (230 V)	3015 W	3215 W
ENERGY EFFICIENCY (1) (3) - PRODUCT FICHE		
Best Performing Mode	ECO	ECO
Energy Efficiency Index (EEI)	80,8	81
Energy Efficiency Class	A+	A+
MARKS AND CERTIFICATES	CE / N / CCA / CB / EAC / G - Mark	CE / N / CCA / CB / G - Mark

12. INSTALLATION DIAGRAMS AND DIMENSIONS

PHT 941

BUILT IN DIAGRAM

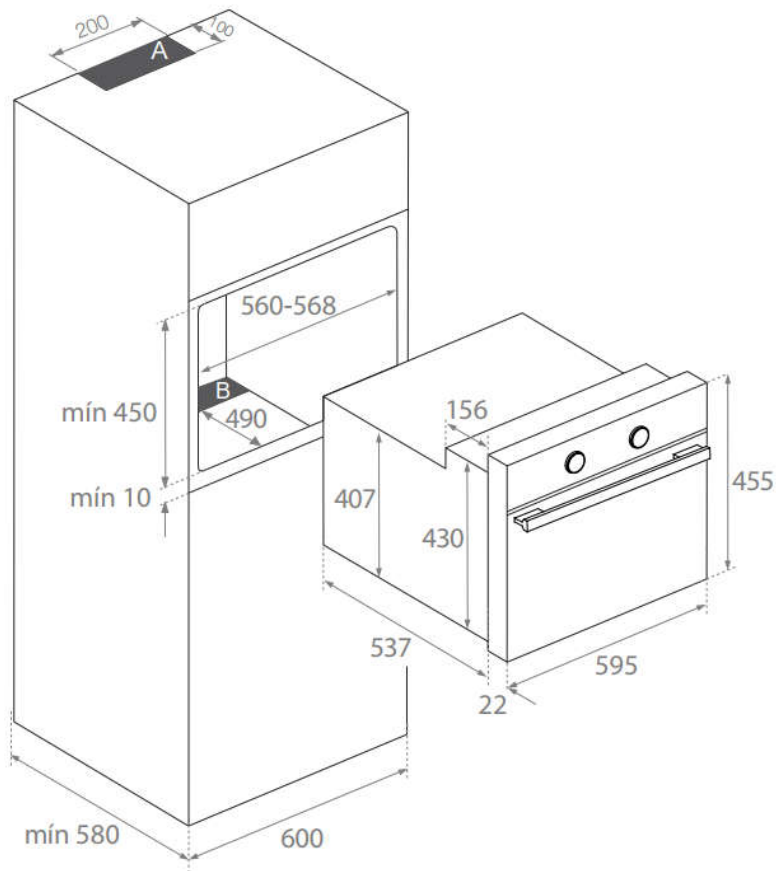
 **NOTE**

Respect the ventilation holes in the cabinet, see installation drawings (200X100mm in zone **A** and 560x90mm in zone **B**). If these vents are not available, the product not work properly and may suffer damage that would NOT be covered by the warranty.

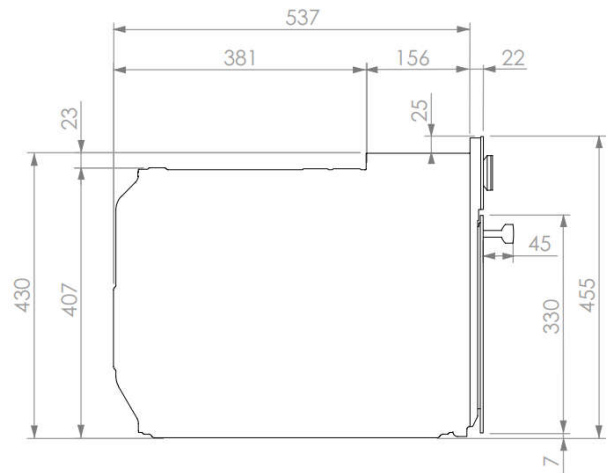

BUILT UNDER DIAGRAM

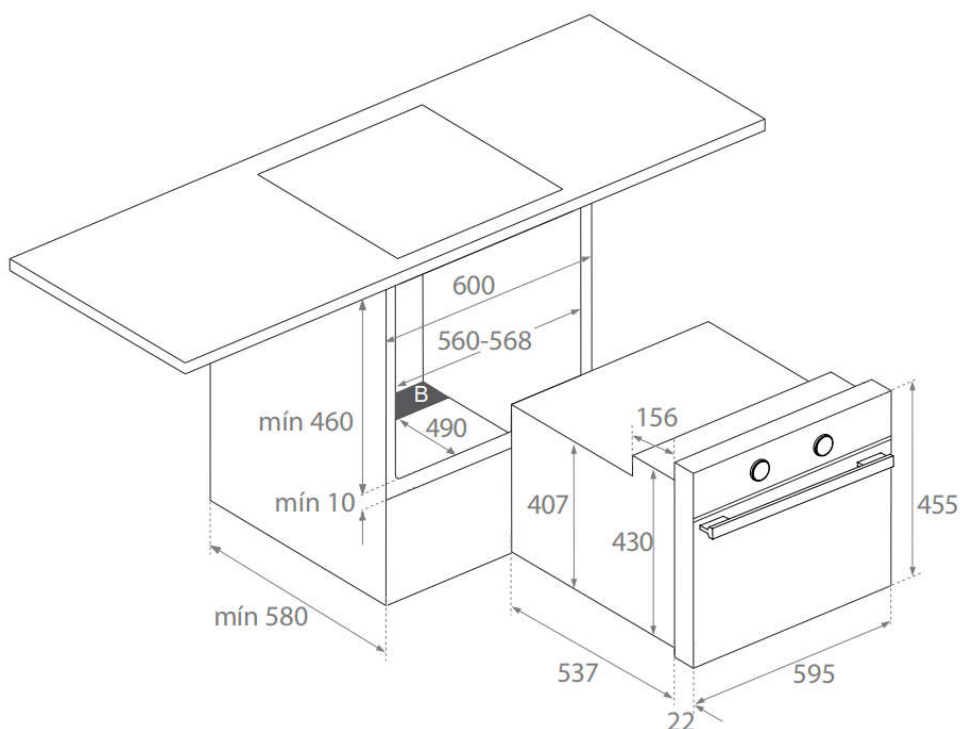

12. INSTALLATION DIAGRAMS AND DIMENSIONS

PHT 963

INSTALACIÓN EN COLUMNA

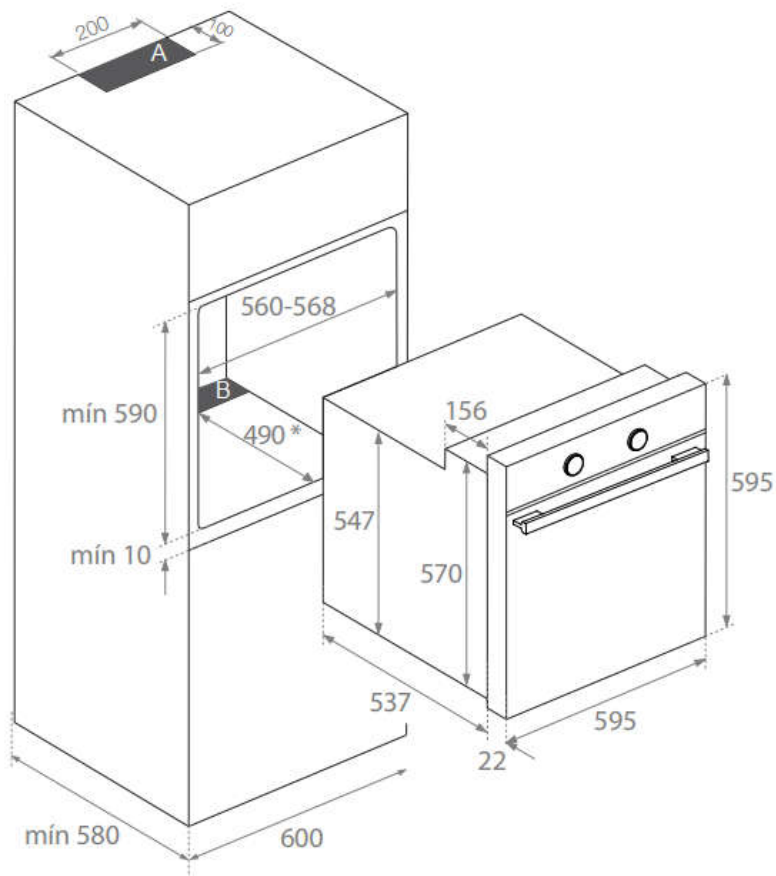

BUILT UNDER DIAGRAM

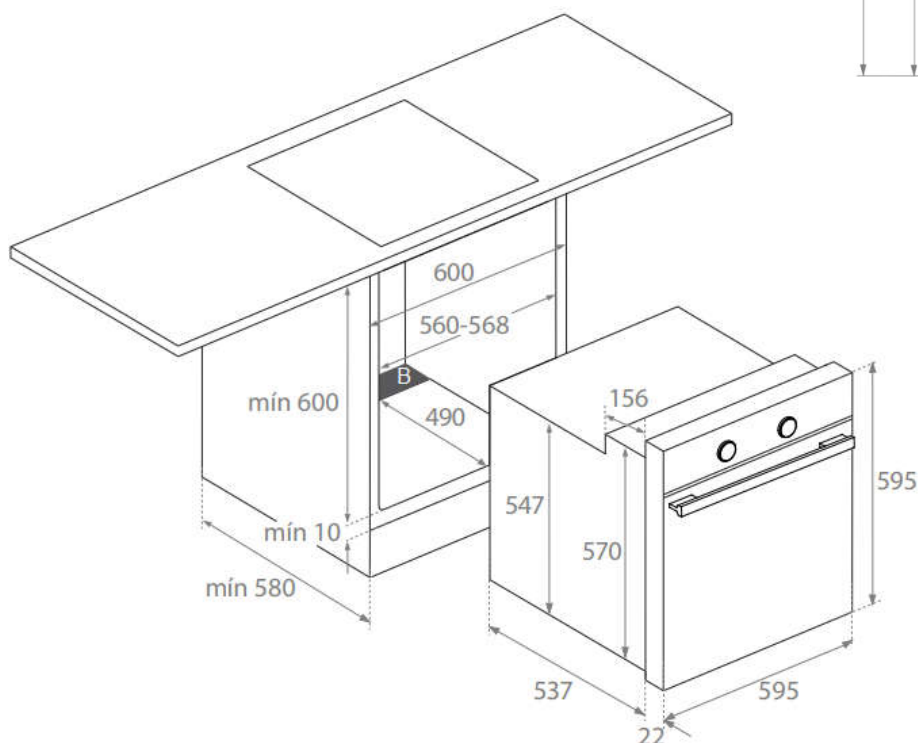
 **NOTE**

Respect the ventilation holes in the cabinet, see installation drawings (200X100mm in zone **A** and 560x90mm in zone **B**). If these vents are not available, the product not work properly and may suffer damage that would NOT be covered by the warranty.

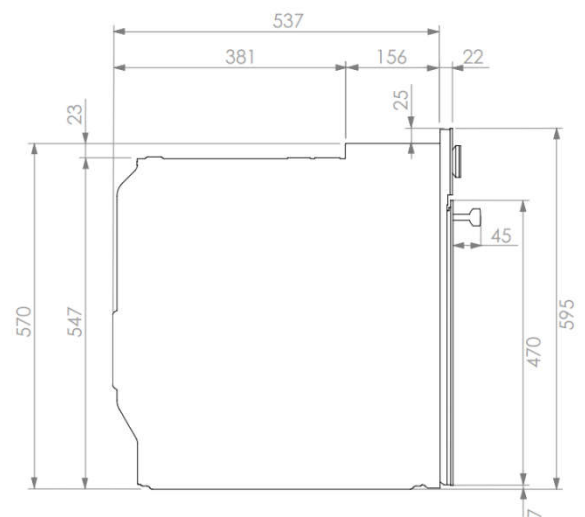

13. AFTER-SALES SERVICE AND GUARANTEE:

INOXPAN S.L., thank you for choosing our brand and for trusting a Pando product, standard of Quality, Design & Innovation, a brand honouring his origins and commitments.

TERMS OF THIS WARRANTY:

This product comes with a warranty of 3 year as from the date of purchase covering all product defect affecting its performance. To validate the same is mandatory to apply the purchasing invoice or buying ticket before the official Customer Service engineer.

During the above mentioned period, the Company pledge to repair or replace at no cost any defective part whose cause is due to vice or manufacturing product flaw to make it work fine again, as well as the necessary labour cost and expenses involved in said repairing or replacement.

PANDO WARRANTY EXEMPTIONS:

It shall not be covered by the warranty or may be cause of cancelation of such, any of the following case scenarios, thus being the user the one taking charge of any material cost, labour and customer service travel expenses:

- Installation or performing reviews, cleaning or maintenance.
- If the installation of the device has not been carried out by Authorized Specialist Professional personnel or Pando Official Technical Service personnel, who meet the requirements of the safety standards and electrical power regulations.
- Whenever the product is orientated to commercial or non-residential use, to which it is not made for.
- Product malfunction caused by not following the instructions, recommendations and/or norms shown in the appliance manuals.
- Malfunctions or problems caused by an inadequate installation, or by not having the necessary free spaces in the furniture and indicated in the installation manual, for adequate ventilation of the product.
- Issues and faults produced by carriage or moves, and/or product handling by non-authorized personnel to this company or the brand Pando.
- Bumps, dents, scratches, or broken glasses
- Other alien bodies present in the interior or exterior of the product
- That the technician does not have easy access to the product, because there are elements that prevent its easy and safe access. All necessary means to access by the Pando authorised engineer shall be on account and responsibility of the user.
- Wiring inadequate handling of external electric cable.
- Wear and tear aesthetical parts, such as light screens, lamps, trays, grills, guides.
- Rust, burns, stains or colour changes in the body, door, accessories or interior cavity caused by improper maintenance or use, or by improper application or unprotected exposure to corrosive elements such as cleaning products not recommended by the manufacturer and inappropriate.
- Issues or malfunction produced by variations of main supply, or natural and random causes from weather or geological origin, as storms, lightning, earthquakes, floods, etc.
- Products whose origin is resale, used appliance, or displays with more than two years since their date of manufacturing.

INOXPAN, S.L., Remains expressly excluded from any liability over any eventual damage any direct or indirect to persons or materials produced by inadequate product handling and use.

Official Pando Customer Service Contact Details:

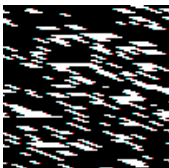
ESPAÑA, PORTUGAL Y ANDORRA:	OTROS PAÍSES:
<p>ES www.pando.es/asistencia-tecnica/</p> 	<p>EN https://www.pando.es/en/after-sales-services/</p> <p>FR https://www.pando.es/fr/service-apres-vente/</p> 

“Wir freuen uns sehr, dass Sie eines unserer Produkte erworben haben, sowie über das Vertrauen, welche Sie damit der Marke Pando entgegen bringen. Wir sind davon überzeugt, dass Sie die richtige Entscheidung getroffen haben.

Pando Produkte entsprechen nicht nur den höchsten Qualitätsansprüchen unserer Kunden, sondern wir verfügen auch über ein Team von Experten, welches Ihnen für jegliche produktbezogene, technische Fragen, oder Anfragen bzgl. Installation und Wartung etc., jederzeit zur Verfügung steht und Sie sehr gerne auch weiterführend berät.

Wir laden Sie ein, unsere Webseite (www.pando.es) zu besuchen, um uns besser kennenzulernen. Dort erhalten Sie einen Überblick über unser gesamtes Produktportfolio, inklusive umfassender verkaufs- und technischer Produktinformation.

Sie werden ein sehr umfangreiches Programm an designorientierten, dekorativen Dunstabzugshauben finden, mit jeweils vielfältigen Lösungen für alle 4 Installationsmöglichkeiten: Wand-, Insel-, Decken- und komplett in Küchenmöbel integrierte Dunstabzugshauben, was es ermöglicht, dass Sie bei Pando für jede Küchensituation garantiert immer die passende Haube finden.

Desweiteren zeigen wir auf unserer Webseite auch das restliche Portfolio an Pando Kücheneinbauprodukten, wie z.B. voll integrierte Spülmaschinen, Multifunktionsöfen und Einbau-Mikrowellengeräte, sehr hochwertige Weinkühlschränke und Weinlagerschränke für die perfekte, professionelle kurz-, sowie langfristige Aufbewahrung Ihrer besten Weine, sowie diverse Induktions- und Gaskochfelder.

All dies verbunden unter der Traditionsmarke PANDO, welche seit mehr als 40 Jahren von Barcelona (Spanien) aus, nicht nur für eine ausgezeichnete Produktqualität steht, sondern auch immer bemüht ist, selbst besondere, spezifische Anforderungen unsere Kunden zu erfüllen.

An dieser Stelle bleibt uns nur noch, uns zu verabschieden, sowie uns nochmals dafür zu bedanken, dass Sie für sich und Ihre Wohnung ein Pando Produkt ausgewählt haben, und Ihnen viel Freude mit Pando zu wünschen.

Das gesamte Pando Team”

1. BACKOFENBESCHREIBU	5
2. BEDIENFELD	5
3. EINSCHALTEN UND UHREINSTELLUNG	6
4. BESCHREIBUNG DES BEDIENFELD	7
4.1. Startanzeige.....	7
4.2. Auswahlbild.....	8
4.3. Kochanzeige.....	9
5. NUTZUNG DER HERKÖMMLICHEN GARFUNKTIONE	10
5.1. Backofenfunktionen	10
5.2. Nutzung der herkömmlichen gar funktionen	11
5.3. Automatische schnellvorheizung	11
6. KOCHEN MIT DEM PERSÖNLICHEN GARASSISTENTEN (<i>PANDO CHEF</i>)	12
6.1. Automatische backofen-rezepte	12
6.2. Nutzung des persönlichen garassistenten	13
6.3. Leeren backofen vorheizen	14
6.4. Gargut wenden.....	14
7. ZEITEINSTELLUNG DES BACKOFENS	15
7.1. Optionen der zeiteinstellung	15
7.2. Programmierung der optionen der zeiteinstellung	16
8. SICHERHEITSFUNKTIONEN	17
8.1. Kindersicherung (sperre des bedienfelds).....	17
9. FUNKTION SCS (STEM CLEAN SYSTEM BY PANDO)	18
10. DEMO-MODUS (SONDERFUNKTION FÜR AUSSTELLUNGEN)	20
11. TECHNISCHE SPEZIFIKATIONEN	21
12. INSTALLATION SCHEMES UND ABMESSUNGEN	22
13. GARANTIEURKUNDE PANDO	24

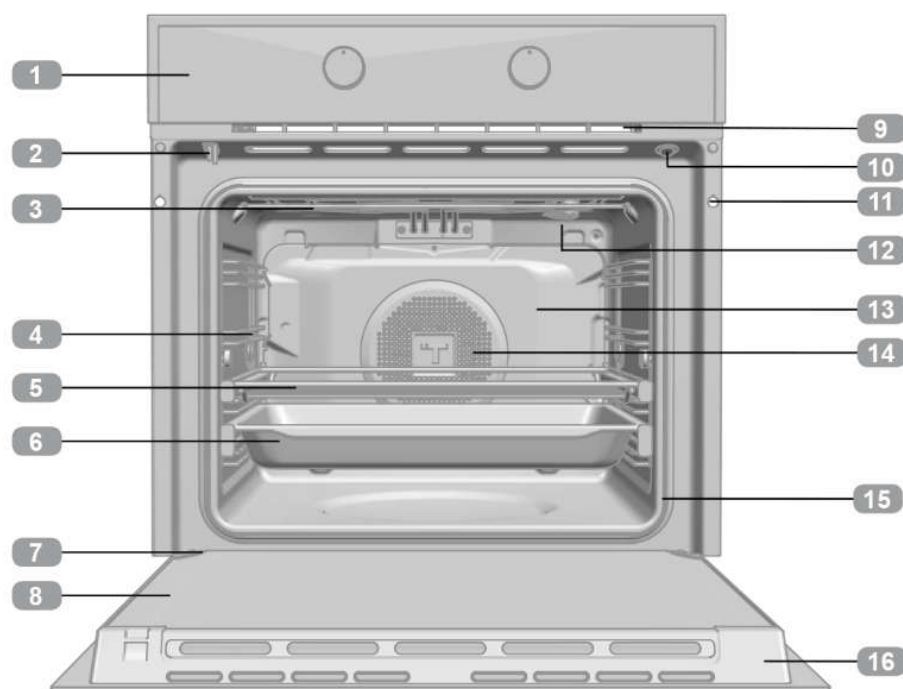
1. BACKOFENBESCHREIBU

- 1 Bedienfeld
- 2 Sperre / Türschalter (nur für Pyrolyse-Modelle)
- 3 Grillwiderstand
- 4 Führungsschienen
- 5 Rost
- 6 Backblech
- 7 Scharnier
- 8 Innenscheibe
- 9 Kühlluftaustritt
- 10 Türschalter (nur für Modelle OHNE Pyrolysefunktion)
- 11 Befestigung am Einbauschrank
- 12 Lampe
- 13 Rückwand
- 14 Heißluft-Ventilator
- 15 Backofendichtung
- 16 Tür

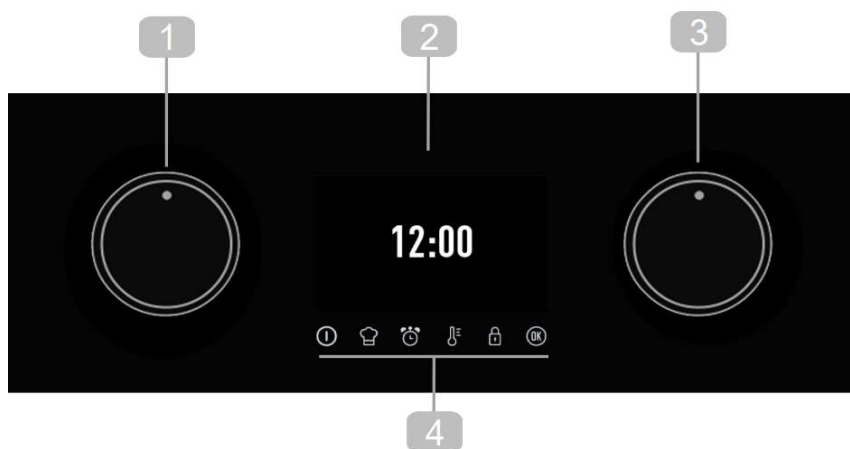
2. BEDIENFELD

- 1 Schalter zur Navigation in den Menüs auf der linken Seite. Wahlschalter Garfunktionen.
- 2 Anzeigebild.
- 3 Schalter zur Navigation in den Menüs auf der rechten Seite. Wahlschalter zur Einstellung der Garfunktionen.
- 4 Tasten.

① **Backofen Ein/ Ausschalten.**

 **Zugang zum persönlichen Garassistenten (PANDO CHEF)**

 **Zugang zu den Funktionen zur Zeiteinstellung und programmierung des Backofens.**

 **Änderung der Backofentemperatur.**

 **Ein/ausschalten der tastatur/ türsperre je nach Modell.**



Ⓞ **Bestätigungstaste, Aus/Einschalten innenbeleuchtung.**

3. EINSCHALTEN UND UHREINSTELLUNG

Wird der Backofen zum ersten Mal an das Stromnetz angeschlossen, erscheint das Logo und anschließend blinkt die Anzeige 12:00.

Um den Backofen benutzen zu können, muss die Uhrzeit eingestellt werden.

EINSTELLEN DER UHRZEIT:

- Stellen Sie mit der linken Taste die Stunden ein, und dann mit der rechten Taste die Minuten. Bestätigen Sie die Auswahl mit der Taste  oder warten Sie einige Sekunden.
- Wählen Sie mit der rechten Taste den Grafiktyp für die Anzeige der Uhrzeit aus. Bestätigen Sie die Auswahl mit der Taste  oder warten Sie einige Sekunden.

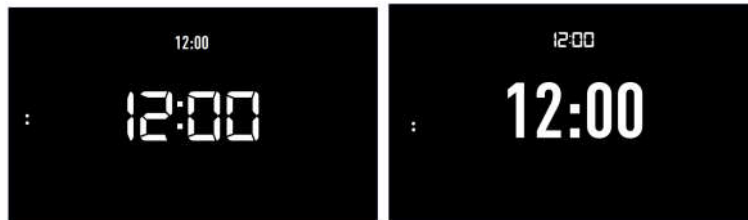

Als Bestätigung hören Sie ein akustisches Signal und die Uhrzeit wird auf dem Bildschirm angezeigt.

Änderung der Uhrzeit:

Bei ausgeschaltetem Backofen (Startbild) die Taste  gedrückt halten, bis die Uhrzeit zu blinken beginnt. Befolgen Sie dann die Schritte zur Änderung der Uhrzeit.



ACHTUNG

Die Empfindlichkeit der Touch-Tasten passt sich ständig an die Umgebungsbedingungen an. Beim Anschluss des Ofens an das Stromnetz ist darauf zu achten, dass die Oberfläche des Bedienfelds sauber und frei von Hindernissen ist.

Reagiert die Anzeige bei der Berührung des Glases nicht richtig, muss der Backofen vom Stromnetz getrennt und nach einem Augenblick wieder angeschlossen werden. Auf diese Weise stellen sich die Sensoren automatisch richtig ein und reagieren wieder auf Berührung mit dem Finger.



ACHTUNG

Bei einem Stromausfall wird die gesamte Programmierung der elektronischen Uhr gelöscht. Als Anzeige erscheint dann 12:00.

Sie können die Uhrzeit entsprechend den obigen Anweisungen einstellen.

Wenn die Backofentür vor dem Stromausfall gesperrt war, leuchtet das Sperrsymbol auf, bis die Tür entsperrt wird.

Dies kann in Abhängigkeit von der Temperatur des Backofens mehrere Minuten dauern. Während dieser Zeit können Sie die Uhr nicht einstellen.

Sobald die Tür entsperrt ist, können Sie die Uhrzeit einstellen, indem Sie die o. a. Anweisungen befolgen.

4. BESCHREIBUNG DES BEDIENFELD

Im Anschluss sind die Informationen beschrieben, die auf dem Display Ihres Backofens angezeigt werden.

4.1. STARTANZEIGE

Diese Anzeige erscheint, wenn der Backofen nicht in Betrieb, aber an die Stromversorgung angeschlossen ist.

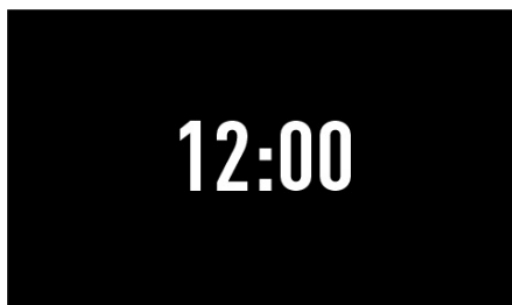

Wenn die Tastatursperre aktiviert ist, wird das Symbol  oben angezeigt.

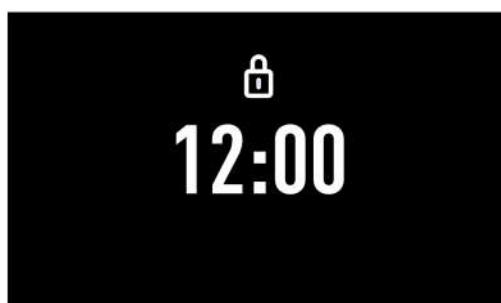

Wurde ein Alarm programmiert, wird nicht die Uhrzeit angezeigt, sondern der Countdown (siehe die folgende Abbildung).

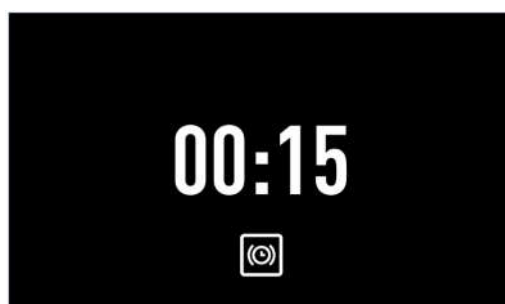

4.2. AUSWAHLBILD

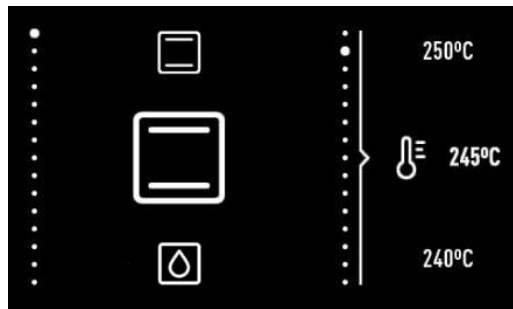

STARTANZEIGE:

- Schalten Sie das Gerät mit dem Ein/Aus Schalter ein ⓘ

Diese Anzeige erscheint, wenn der Backofen nicht in Betrieb, aber an die Stromversorgung angeschlossen ist:

LINKER BEREICH:

In diesem Bereich werden die für die Auswahl verfügbaren Garfunktionen, die automatischen Rezepte oder die Programmierfunktionen der Uhr dargestellt.

Um eine Funktion auszuwählen, den linken Schalter drehen, bis die gewünschte Funktion vergrößert erscheint, und die Auswahl mit der Taste ⓘ bestätigen (wenn keine Taste berührt wird, bestätigt der Backofen die Auswahl nach ein paar Sekunden automatisch).

RECHTER BEREICH:

In diesem Bereich werden die Werte angezeigt, die entsprechend der gewählten Funktion ausgewählt werden können: Temperatur, Gewicht, Dauer, Ende der Garzeit...

Um einen Wert auszuwählen, den rechten Schalter drehen, bis der gewünschte Wert vergrößert erscheint, und die Auswahl mit der Taste ⓘ bestätigen (wenn keine Taste berührt wird, bestätigt der Backofen die Auswahl nach ein paar Sekunden automatisch).

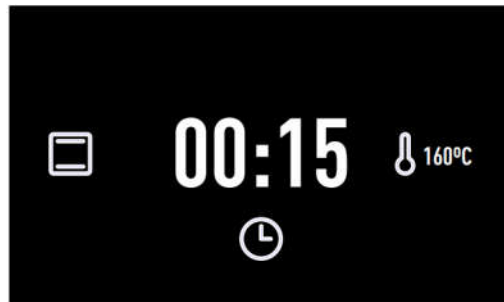
4.3. KOCHANZEIGE

Während des Garvorgangs können Informationen zum Status des Ofens auf dem Bildschirm angezeigt werden. Diese Daten sind um die weissen Ziffern der Zeitanzeige herum angeordnet.

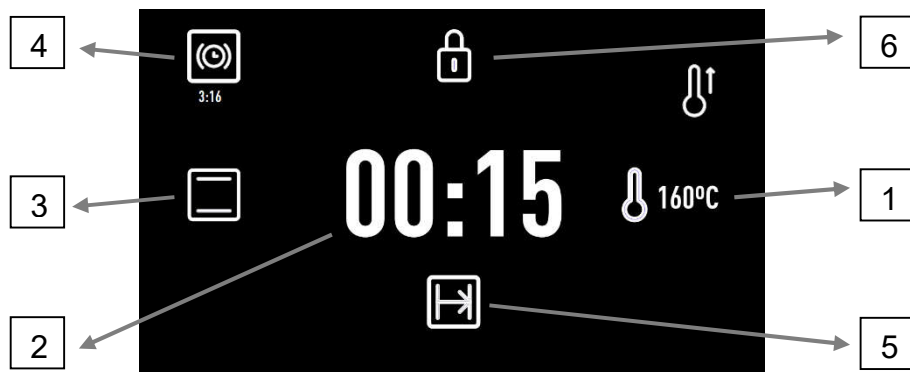
**1. Gewählte temperatur**

Das  blinkt, bis die gewählte Temperatur erreicht ist, und immer dann, wenn der Backofen das Gargut erhitzt.

2. Gardauer:

Wenn die Uhr nicht programmiert wurde, wird die Dauer angezeigt, die der Backofen schon gart. Wurde eine Programmierung vorgenommen, wird die Zeit angezeigt, die bis zum Ende der Garzeit aussteht (Countdown).

Wenn der Backofen programmiert ist, sich aber noch in der Wartezeit befindet (der Garvorgang hat noch nicht begonnen), wird die Gesamtdauer der programmierten Garzeit angezeigt.

3. Kochfunktion oder ein ausgewähltes automatisches Rezept.

Wenn Sie Zeitfunktionen programmiert haben, dann wird die Information zu diesen Funktionen auf dem Bildschirm angezeigt.

4.  **Timer:** Countdown bis zum Ablauf des programmierten Alarms.

5.  **Endzeit:** Wenn Sie Sicherheitsfunktionen aktiviert haben, dann wird die Information zu diesen Funktionen auf dem Bildschirm angezeigt

6.  **Tastatursperre:** Leuchtet, wenn die Kindersicherung eingeschaltet ist.

5. NUTZUNG DER HERKÖMMLICHEN GARFUNKTIONE**5.1. BACKOFENFUNKTIONEN****HINWEIS**

Für eine Beschreibung der einzelnen Funktionen lesen Sie bitte die im Lieferumfang Ihres Backofens enthaltene Übersicht über die Garfunktionen.

**AUSSCHALTEN****NORMAL** **NORMAL MIT UMLUFT** **GRILL UND UNTERHITZE** **MAXIGRILL****GRILL****UNTERHITZE** **PIZZA** **TURBO** **NIEDERTEMPERATUR-GAREN****TEIGE AUFGEHEN LASSEN****AUFTAUEN****ECO****SCS (Steam Cleaning System by PANDO)****Funktionen mit automatischer schnellvorheizung**

5.2. NUTZUNG DER HERKÖMMLICHEN GAR FUNKTIONEN

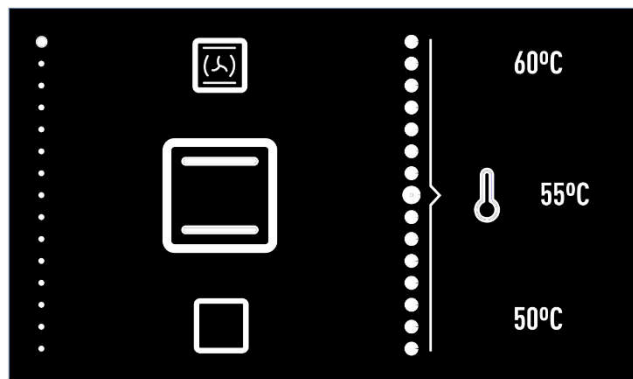

Selección de función.

Schalten Sie den Backofen ein, indem Sie die Taste  berühren.



Drehen Sie den linken Schalter, bis die gewünschte Funktion vergrößert erscheint.

Anschließend erscheint rechts die für die gewählte Funktion empfohlene Temperatur.

Wenn gewünscht, können Sie diese Temperatur ändern, indem Sie den rechten Schalter drehen.

Bestätigen Sie die Auswahl mit der Taste . Der Backofen startet den Garvorgang.

Während des Garvorgangs können Sie zu jedem beliebigen Zeitpunkt:

- **Die garfunktion ändern**, indem der linke Schalter gedreht wird.
- **Die gartemperatur ändern**, indem der rechte Schalter gedreht wird.
- **Einen alarm oder die Dauer/Endzeit des garvorgangs programmieren** (durch Berühren der Taste .
- **Die programmierung eines alarms oder der Dauer/Endzeit ändern** (durch Berühren der Taste .



HINWEIS

Zur Programmierung oder Änderung einer Programmierung lesen Sie bitte den Abschnitt «Zeiteinstellung des Garvorgangs» weiter unten in dieser Bedienungsanleitung.



























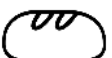





5.3. AUTOMATISCHE SCHNELLVORHEIZUNG

Die angegebenen Funktionen beinhalten eine automatische Schnellvorheizung.

Während der Schnellvorheizung leuchtet das Symbol .

Es wird empfohlen, das Gargut erst dann in den Backofen zu stellen, wenn dieses Symbol nicht mehr aufleuchtet.

6. KOCHEN MIT DEM PERSÖNLICHEN GARASSISTENTEN (PANDO CHEF)**6.1. AUTOMATISCHE BACKOFEN-REZEPTE**

GEFLÜGEL			HÄHNCHEN		
			ENTE		
			GANS		
			PUTE		
FLEISCH			SPANFERKEL		
			OCHSE		
			LAMM		
			KOTELETTS		
FISCH			SEEHECHT		
			LACHS		
BROT			WEISSBROTPAN		
			DUNKLES BROT		
			VOLLKORNBROT		
PIZZAS			DICKE		
			DÜNNE		
NACHSPEISEN			FORMKUCHEN		
			GROSSER OBSTKUCHEN		
			KLEINER OBSTKUCHEN		
			BLECHKUCHEN		

 Rezepte, bei denen der leere Backofen vorgeheizt werden muss.

 Rezepte, bei denen das Gargut gewendet werden muss.

6.2. NUTZUNG DES PERSÖNLICHEN GARASSISTENTEN

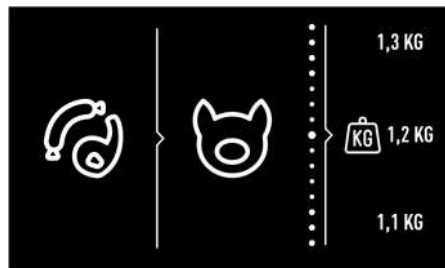

Rezeptauswahl.

Drehen Sie den linken Schalter, bis die Speise, die Sie zubereiten möchten, vergrößert erscheint. Im rechten Bereich werden anschließend die für die gewählte Speiseart verfügbaren Rezepte angezeigt. Wählen Sie das gewünschte Rezept mit dem rechten Schalter und bestätigen Sie die Auswahl mit der Taste **OK**.

Im rechten Bereich erscheinen im Anschluss die Angaben, die der Backofen zum Programmieren des Garvorgangs benötigt.

Je nach gewähltem Rezept fordert der Backofen zur Eingabe folgender Angaben auf:

GEWICHT DES GARGUTS: Wählen Sie das Gewicht mit dem rechten Schalter und bestätigen Sie es mit der Taste **OK**.

TEMPERATUR: Bestätigen Sie die vorgeschlagene Temperatur oder wählen Sie mit dem rechten Schalter eine andere. Bestätigen Sie sie mit der Taste **OK**.

GARSTUFE: Bei einigen Zubereitungen können Sie die Garstufe wählen:

- **HIGH:** Well done
- **MEDIUM:** Medium
- **LOW:** Rare

Nachdem alle Parameter ausgewählt wurden, müssen Sie sie mit der Taste **OK** bestätigen.

Der Backofen startet den Garvorgang und die Auswahlanzeige wechselt zur Garanzeige, auf der folgende Informationen zu sehen sind:

- Gewählte Gartemperatur
- Restliche Garzeit
- Gewähltes Rezept

Nach Beendigung des Garvorgangs ertönt ca. 90 Sekunden lang ein akustisches Signal und auf der Anzeige blinkt das Garsymbol. Berühren Sie eine beliebige Taste, um den Ton auszuschalten.

Der Backofen schaltet sich automatisch ab.



HINWEIS

In den ersten 10 Minuten der Garzeit können Sie Gewicht und Garstufe ändern oder die Endzeit des Garvorgangs programmieren.

Nach dieser Zeit können diese Werte nicht mehr geändert werden.

Um diese Garparameter zu ändern, müssen Sie die Taste  berühren, um zur Auswahlanzeige zurückzukehren. Befolgen Sie dann die o. a. Schritte.

Während des Garvorgangs können Sie zu jedem beliebigen Zeitpunkt:

Die Gartemperatur ändern, indem sie die Taste berühren und mit der Taste **OK** bestätigen.

Einen alarm programmieren (durch Berühren der Taste .

Die Programmierung eines alarms ändern (durch Berühren der Taste .

Zur Programmierung oder Änderung einer Programmierung befolgen Sie bitte die Anweisungen im Abschnitt «Zeiteinstellung des Garvorgangs» weiter unten in dieser Bedienungsanleitung.

6.3. LEEREN BACKOFEN VORHEIZEN

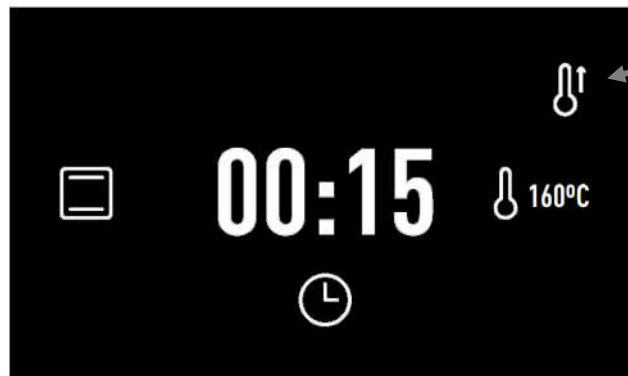



Bei den in der Tabelle mit dem Symbol  gekennzeichneten Rezepten muss das Gargut in den zuvor vorgeheizten Backofen gestellt werden.

Wird eines dieser Rezepte gewählt, erscheint bei Garbeginn das Symbol  auf der Anzeige. Sobald der Backofen die Gartemperatur erreicht hat, blinkt das Symbol und es ertönt ein akustisches Signal, das angibt, dass das Gargut nun hineingestellt werden kann.

Das akustische Signal verstummt beim Öffnen der Backofentür zum Einführen des Garguts automatisch. Auf der Garanzeige wird die verbleibende Zeit angegeben.

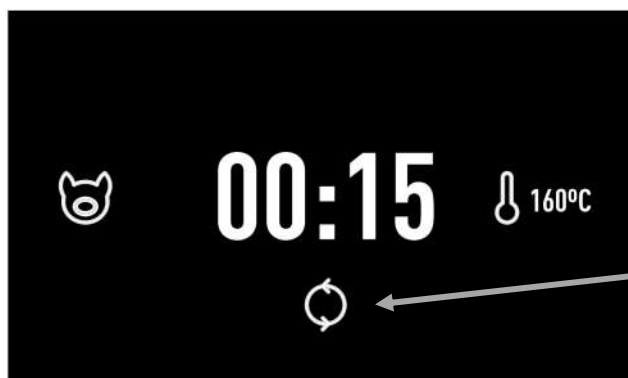
6.4. GARGUT WENDEN



Bei den in der Tabelle mit dem Symbol  gekennzeichneten Rezepten muss das Gargut während des Garvorgangs gewendet werden.

Der Backofen weist Sie auf diesen Zeitpunkt mit einem akustischen Signal hin, und auf der Garanzeige erscheint das Symbol .

Das akustische Signal verstummt automatisch, wenn die Backofentür zum Wenden des Garguts geöffnet wird.

7. ZEITEINSTELLUNG DES BACKOFENS

7.1. OPTIONEN DER ZEITEINSTELLUNG

Folgende Optionen stehen zur Zeiteinstellung beim Programmieren eines Garvorgangs zur Verfügung:

 **Timer:** Programmiert einen Alarm, der nach Ablauf der eingestellten Zeit ertönt. Der Garvorgang wird nach Ablauf der Zeit NICHT unterbrochen. Sie können auch einen Alarm erstellen, wenn der Backofen nicht in Betrieb ist.

HINWEIS

Sie können jederzeit, d. h. unabhängig davon, ob der Backofen in Betrieb ist oder nicht, einen Alarm programmieren. Die restlichen Optionen der Zeiteinstellung sind nur verfügbar, wenn der Backofen in Betrieb ist.

 **Gardauer:** Damit kann die gewünschte Gardauer gewählt werden.



Nach Ablauf der programmierten Dauer ertönt ein akustisches Signal, das Symbol  blinkt und der Backofen hört automatisch auf zu heizen.

Berühren Sie eine beliebige Taste, um den Alarmton und den Backofen auszuschalten.

 **Garzeit-Ende:** Damit kann die Uhrzeit gewählt werden, bis zu der der Backofen garen soll.

Sobald die programmierte Uhrzeit erreicht ist, ertönt ein akustisches Signal, das Symbol  blinkt und der Backofen hört automatisch auf zu heizen.

Berühren Sie eine beliebige Taste, um den Alarmton und den Backofen auszuschalten.

- **Verzögerter garbeginn** ( **gardauer** +  **garzeit-Ende**): Damit kann der Backofen so programmiert werden, dass er den Garvorgang automatisch beginnt und sich automatisch abschaltet, sobald die programmierte Gardauer abgelaufen ist.

HINWEIS

Zur Programmierung dieser Option müssen Gardauer und Garzeit-Ende nacheinander programmiert werden.

Sie haben während des Garvorgangs jederzeit Zugriff auf die Programmieroptionen.

Auf die gleiche Weise können Sie auch eine bereits festgelegte Programmierung ändern.

10 Sekunden vor Beginn des programmierten Timings ertönt ein Signalton, den Sie durch Drücken einer beliebigen Taste abbrechen können.

Am Ende der Programmierung ertönt erneut ein Signalton, den Sie durch Drücken einer beliebigen Taste abbrechen können.

Wenn Sie keine Taste drücken, ist der Signalton nach 2 Minuten nicht mehr zu hören.

HINWEIS

Wenn Sie ein automatisches Rezept gewählt haben, bestimmt der Backofen die Gardauer automatisch. Aus diesem Grund ist diese Option nicht verfügbar.

In diesem Fall können Sie jedoch:

Die Endzeit in den ersten zehn Minuten des Garvorgangs programmieren.

Jederzeit einen Alarm programmieren.

7.2. PROGRAMMIERUNG DER OPTIONEN DER ZEITEINSTELLUNG

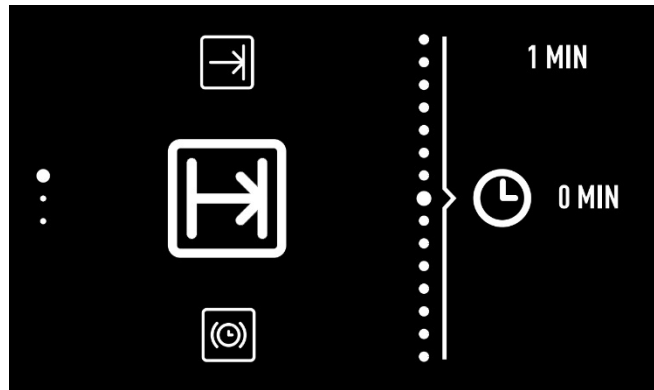

Programmierung der Gardauer

1. Berühren Sie die Taste , um zum Menü der Optionen der Zeiteinstellung zu gelangen.
2. Drehen Sie den linken Schalter, um die gewünschte Programmieroption zu wählen.
3. Drehen Sie den rechten Schalter, um die Gardauer oder das Garzeit-Ende je nach gewählter Option einzustellen.



HINWEIS

Es ist nicht möglich, ein Garzeit-Ende zu wählen, das vor der aktuellen Uhrzeit liegt. Beim Programmieren des Garzeit-Endes wird als Hilfestellung die aktuelle Uhrzeit in der Mitte angezeigt.



- 4 Bestätigen Sie die Auswahl mit der Taste .
- 5 Anschließend erscheint erneut die Garanzeige. Sie können die programmierten Zeiteinstellungen rechts neben dem mittleren Kreis sehen.

8. SICHERHEITSFUNKTIONEN

8.1. KINDERSICHERUNG (SPERRE DES BEDIENFELDS)

Diese Funktion kann jederzeit eingeschaltet werden:

- **Bei ausgeschaltetem Backofen.** Die Kindersicherung verhindert, dass der Backofen durch Betätigung der Taste  eingeschaltet werden kann.
- **Beim Gebrauch des Backofens.** Wird die Funktion eingeschaltet, während der Backofen in Betrieb oder in Wartestellung ist, wird die Tastatur gesperrt, so dass keine Schalter betätigt und keine Garwerte geändert werden können.

Um die Funktion zu aktivieren, die Taste  so lange berühren, bis 1 Piepton ertönt und das Symbol  auf der Anzeige erscheint. Das Bedienfeld ist gesperrt.

Um die Funktion auszuschalten, die Taste  erneut so lange berühren, bis 1 Piepton ertönt und das Symbol  auf der Anzeige erscheint.

9. FUNKTION SCS (STEM CLEAN SYSTEM BY PANDO)

Mit dieser Funktion wird die Reinigung der Fettund Schmutzreste, die an den Backofenwänden haften, erleichtert.

Verhindern Sie die Ansammlung von Schmutz, damit die Reinigung leichter erfolgen kann. Reinigen Sie den Backofen regelmäßig.

PROGRAMMIERUNG DER FUNKTION SCS



ACHTUNG

Gießen Sie kein Wasser in den heißen Backofen. Dadurch könnte die Emaillierung beschädigt werden.

Führen Sie den Reinigungszyklus stets bei kaltem Ofen aus. Wenn Sie ihn bei zu heißem Backofen durchführen, kann das Ergebnis beeinträchtigt und außerdem die Emaillierung beschädigt werden. Entfernen Sie zuvor die Bleche und alle Zubehörteile inkl. die Führungsschienen bzw. Teleskopauszüge aus dem Backofeninneren.

Befolgen sie dafür die anweisungen im Einbauund Wartungshandbuch, das im lieferumfang des Backofens enthalten ist.

1. Legen Sie bei kaltem Backofen ein Tuch flach auf den Backofenboden.

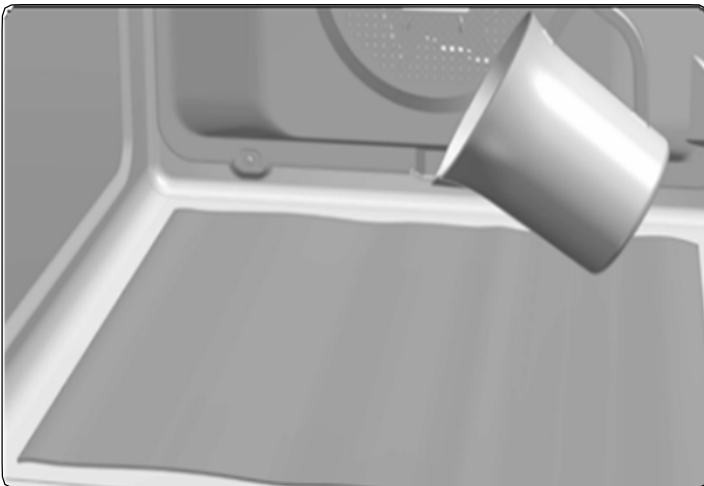



2. Gießen Sie langsam 200 ml Wasser unten in Backofeninnenraum.





HINWEIS

Um das Ergebnis zu verbessern, können Sie dem Glas Wasser einen Teelöffel mildes Geschirrspülmittel hinzufügen, bevor sie es auf das Tuch gießen.

3. Schalten Sie den Backofen ein, drehen Sie den linken Schalter zur Wahl der Funktion  und bestätigen Sie sie mit .
4. Anschließend ertönt ein akustisches Signal zur Bestätigung, dass die SCS Funktion eingeschaltet wurde.

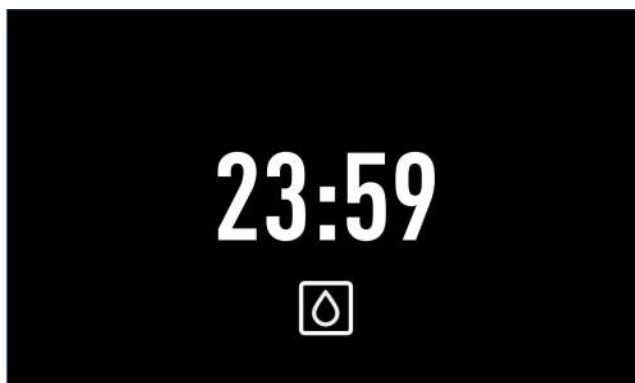
Auf dem Bildschirm erscheinen das Symbol  und die restliche Dauer, bis die Funktion beendet ist. Die Dauer ist auf 24 Minuten voreingestellt.

**WICHTIG**

Die Dauer dieser Funktion kann nicht geändert werden. Um sie vorzeitig zu beenden, müssen Sie den Backofen mit der Taste  ausschalten.

5. Nach Ablauf der programmierten Zeit schaltet sich der Backofen aus, es ertönt ein akustisches Signal und das Symbol  blinkt schnell.

**WICHTIG**

Öffnen Sie die Ofentür nicht, bis die SCS Funktion beendet ist. Die Abkühlphase ist für den korrekten Ablauf der Funktion notwendig.

6. Berühren Sie mit dem Finger eine beliebige Taste, um das akustische Signal und das Symbol  auszuschalten.

7. Der Backofen schaltet sich automatisch ab.

8. Nun können Sie die Schmutzreste und das übrige Wasser mit dem Tuch entfernen.

Die SCS Funktion wird bei niedriger Temperatur durchgeführt. Die Abkühlzeit kann jedoch je nach Außentemperatur unterschiedlich sein.

**ACHTUNG**

Vergewissern Sie sich, dass die Innenflächen des Ofens ausreichend abgekühlt sind, bevor Sie sie berühren.

Sollte nach der SCS Funktion eine gründlichere Reinigung erforderlich sein, verwenden Sie neutrale Reinigungsmittel und nicht scheuernde Schwämme.

10. DEMO-MODUS (SONDERFUNKTION FÜR AUSSTELLUNGEN)

Bei eingeschaltetem DEMO-Modus kann der Backofen ohne Aufheizen bedient werden.

Es wird empfohlen, diesen Modus einzuschalten, wenn der Backofen mit Netzanschluss auf einer Ausstellung installiert wird.

Einschalten des DEMO-Modus

Bevor die Uhrzeit eingestellt wird, gleichzeitig die Tasten   und drücken, bis auf dem Bildschirm die Anzeige «DEMO Mode ON» erscheint.

Anschließend die Uhrzeit einstellen.

Die Bezeichnung «DEMO» erscheint ständig auf dem Bildschirm und der Backofen kann normal bedient werden, heizt aber nicht.

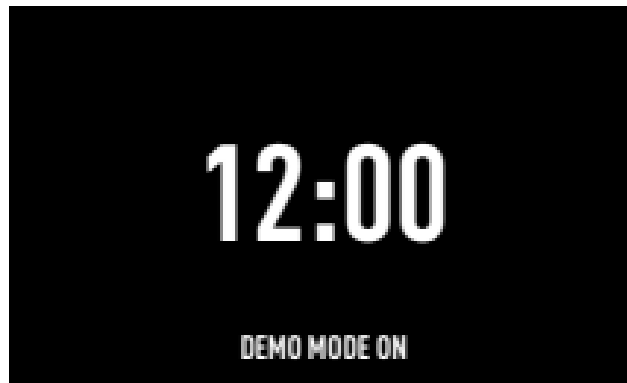

Zum ausschalten des DEMO-Modus muss die Stromversorgung des Backofens abgeschaltet werden.

11. TECHNISCHE SPEZIFIKATIONEN

INSTALLATION	PHT-941	PHT-963
Spannung (V)	220-240	220-240
Freq. (Hz)	50/60	50/60
Zuführungskabel (m)	1,1 m OHNE STECKER	1,1 m OHNE STECKER
Abmessungen anpassen (Höhe x Breite x Tiefe) (mm)	450-460 x 560-568 x 580	590-600 x 560-568 x 580
Produktabmessungen ohne Frontplatte (Höhe x Breite x Tiefe) (mm)	430x545x537	570x545x537
LOGISTIK / VERPACKUNG		
Nettogewicht (Kg)	25	32
Bruttogewicht (Ofen + Verpackung) (Kg)	27	34
Verpackungsabmessungen (Höhe x Breite x Tiefe) (mm)	510x635x655	650x635x655
ZUBEHÖR		
Bedienungsanleitung - Sprachen (2)	ES/PT/UK/FR/GE	ES/PT/UK/FR/GE
Tiefes Fach 30	1	1
Tiefes Fach 50	1	1
Verstärkter Grill	1	1
LEISTUNGEN		
Nützliches Volumen (1) (L)	44	70
Globales Innenvolumen (1) (L)	45	71
Nützliche Kochfläche (1) (cm ²)	1280	1280
Temperaturbereich	30-270 °C	30-270 °C
ELEKTRISCHE LEISTUNGSWERTE		
Widerstand		
Grill + Vault	1.400 W +1.100 W	1.400 W +1.100 W
Unterseite	1.150 W	1.150 W
Kreisförmig	1800	2000
Turbomotor	22	22
Motorkühlung	18 W	18 W
Lichtleistung	25 W	25 W
ERLEUCHTUNG		
INNENLICHT	HALOGEN	HALOGEN
MAXIMALE LEISTUNGSFUNKTION	Bottom + TURBO (Pizza)	Bottom + TURBO (Pizza)
Maximale Ofenleistung (230 V)	3015 W	3215 W
ENERGIEVERBRAUCH (1) (3) (1) (3) -		
Effizientere Funktion	ECO	ECO
Energieeffizienzindex (EEI)	80,8	81
Energieeffizienzklasse	A+	A+
MARKEN UND ZERTIFIKATE	CE / N / CCA / CB / EAC / G - Mark	CE / N / CCA / CB / G - Mark

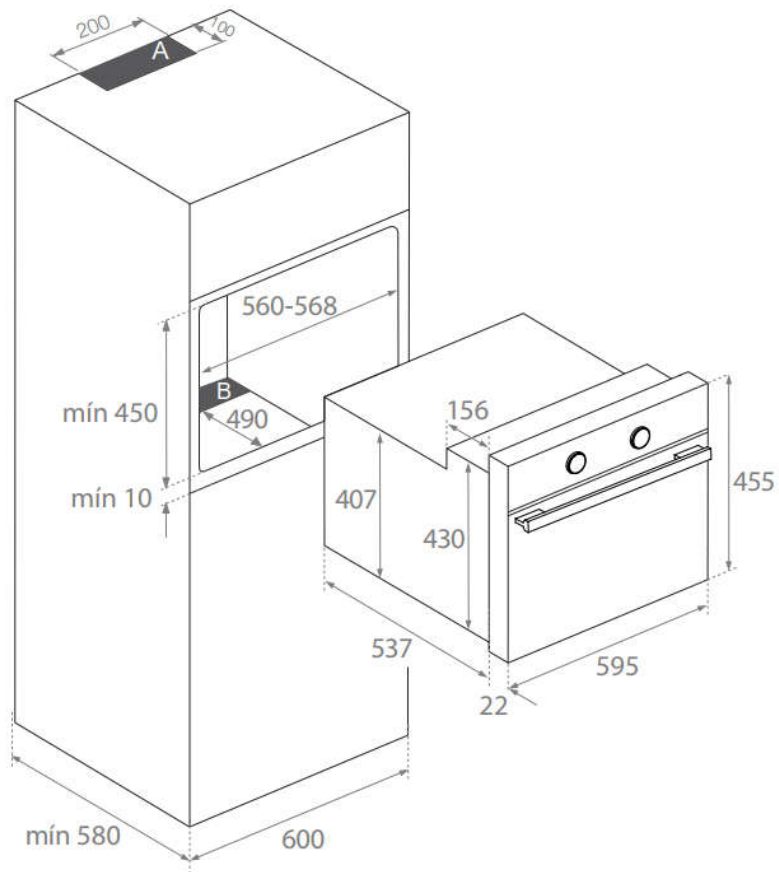
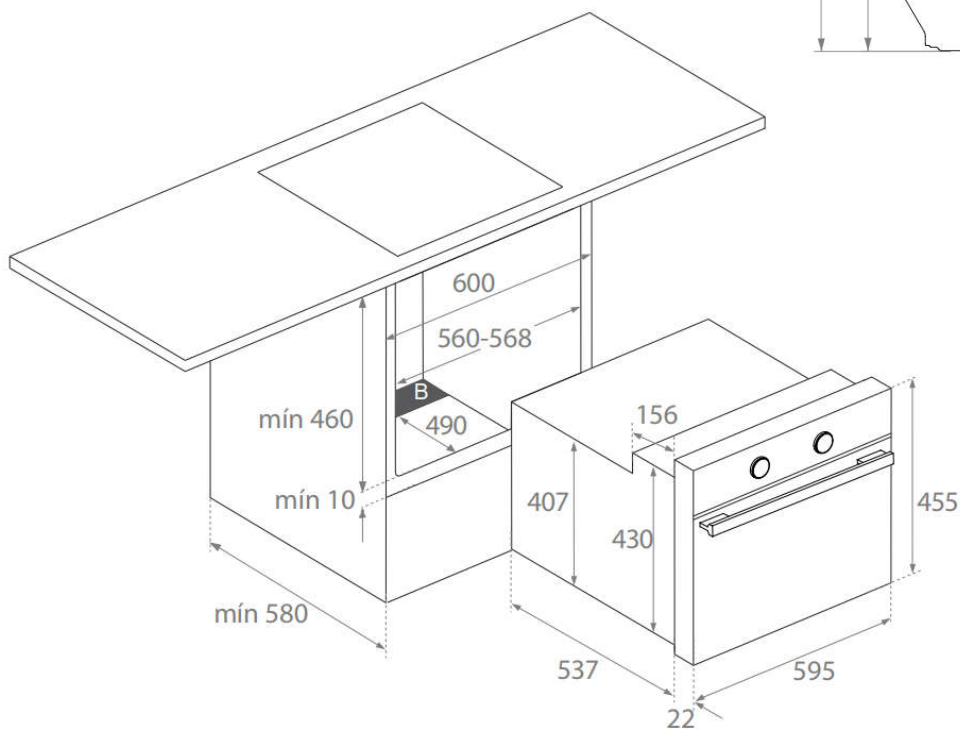
12. INSTALLATION SCHEMES UND ABMESSUNGEN**PHT 941****SPALTENINSTALLATION****INSTALLATION UNTER ARBEITSPLATTE****⚠ WICHTIG**

Beachten Sie die Lüftungsöffnungen im Schrank, siehe Installationszeichnungen (200X100mm in Zone *A und 560X90mm in Zone *B). Wenn diese Lüftungsschlitze nicht verfügbar sind, kann das Produkt Schäden erleiden, die NICHT durch die Garantie abgedeckt sind.

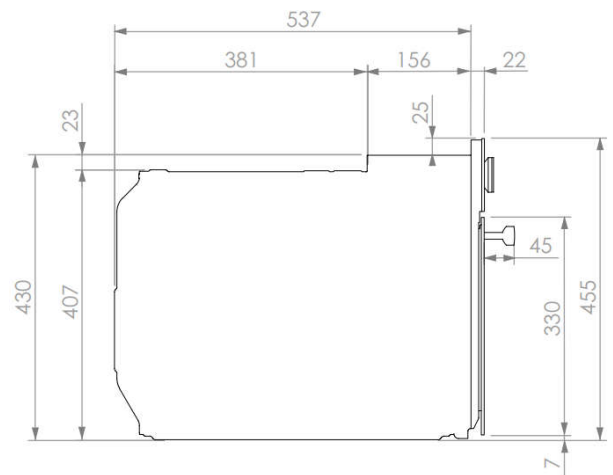

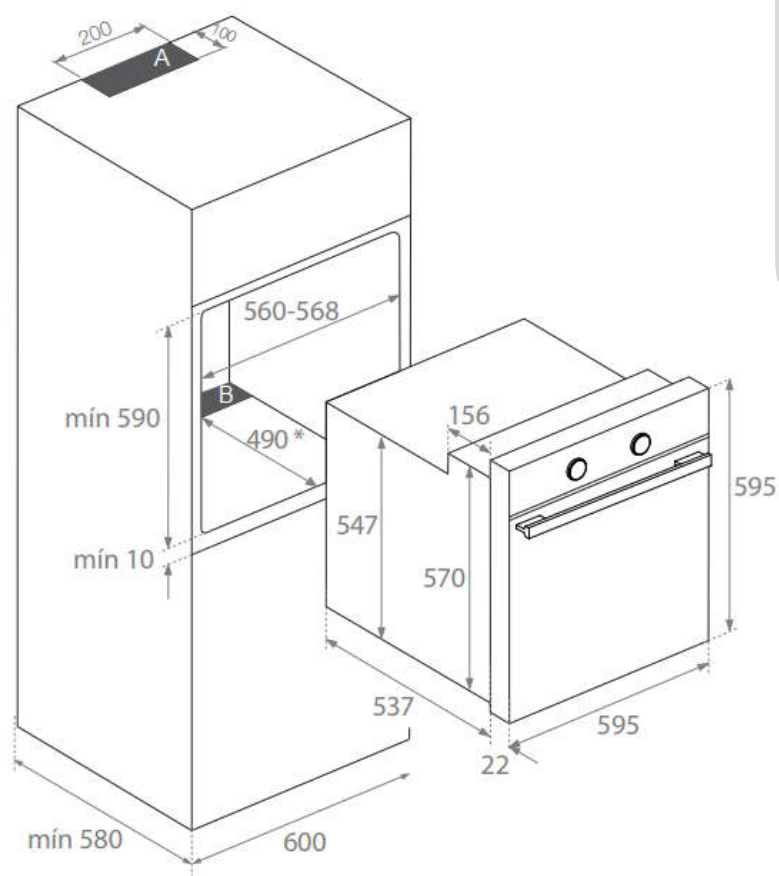
12. INSTALLATION SCHEMES UND ABMESSUNGEN**PHT 963****SPALTENINSTALLATION****⚠ WICHTIG**

Beachten Sie die Lüftungsöffnungen im Schrank, siehe Installationszeichnungen (200X100mm in Zone *A und 560X90mm in Zone *B). Wenn diese Lüftungsschlitze nicht verfügbar sind, kann das Produkt Schäden erleiden, die NICHT durch die Garantie abgedeckt sind.

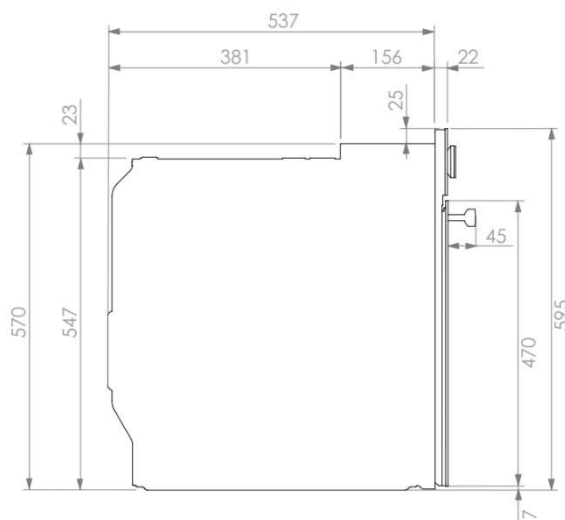
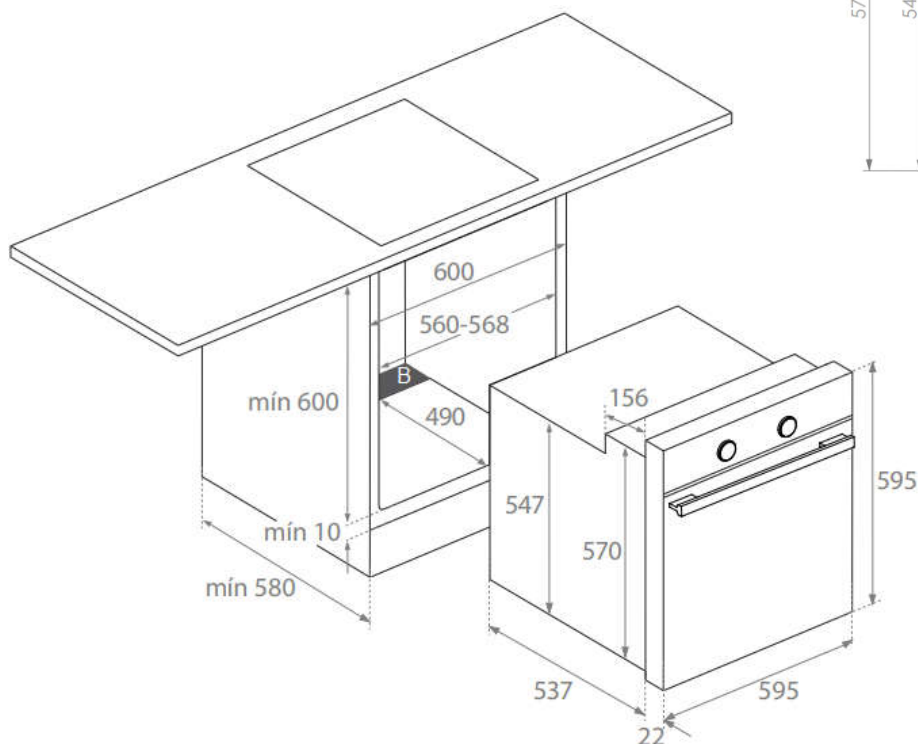
INSTALLATION UNTER ARBEITSPLATTE

13. GARANTIEURKUNDE PANDO

INOXPAN S.L. bedankt sich für den Kauf und für das Vertrauen, das Sie in ein Produkt unserer Marke Pando gesetzt haben. Dieses Produkt ist aufgrund von Qualität, Design und Innovation herausragend und seinem Ursprung und seiner Verpflichtung treu geblieben.

GARANTIEBEDINGUNGEN PANDO:

Wir gewähren **auf dieses Gerät eine Garantie von 3 Jahren ab dem Kaufdatum**. Diese deckt sämtliche Herstellungsfehler ab, welche ein gutes Funktionieren beeinträchtigen könnten. Für die Gültigkeit dieser Garantie ist es unabdingbar, die Rechnung oder das Einkaufsticket dem offiziell autorisierten Pando-Kundendienst vorzulegen. Während dieser Zeit verpflichtet das Unternehmen sich, kostenlos jedes Teil, das aufgrund eines Mangels oder Schadens defekt ist, auszutauschen oder zu reparieren, bis dass ein korrektes Funktionieren erreicht worden ist, sowie den dazu notwendigen Arbeitsaufwand und die infolge dieses Austausches oder der Reparatur entstandenen Aufwendungen zu übernehmen.

AUSSCHLÜSSE AUS DER GARANTIELEISTUNG PANDO:

Die folgenden Fälle werden von der Garantie nicht abgedeckt oder können zu deren Erlöschen führen, wonach der Nutzer die Aufwendungen für Material, Arbeitskraft und Fahrten des technischen Kundendienstes übernehmen muss:

- Überprüfung der Installation oder deren Funktionstüchtigkeit, Reinigung oder Wartung.
- Störungen oder Betriebsausfälle, die aufgrund eines Nicht-Respektierens oder einer Nicht-Befolgung der Sicherheitshinweise oder der Betriebs- und Wartungsempfehlungen aus dem Manual des Geräts hervorgerufen worden sind.
- Wenn die Installation des Geräts nicht von autorisiertem professionellem Fachpersonal oder Personal des technischen Kundendienstes von Pando durchgeführt worden ist, welches die Anforderungen an die Sicherheitsstandards und die Vorschriften für elektrische Installationen erfüllt.
- Wenn das Gerät nicht für den häuslichen Gebrauch verwendet wird, sondern für einen kommerziellen, für den es nicht vorgesehen ist.
- Schlechtes Funktionieren des Produkts aufgrund einer Nicht-Einhaltung der Vorschriften, Anweisungen und Empfehlungen aus den Manualen des Geräts.
- Störungen oder Probleme, verursacht durch eine nicht sachgemäße Installation, oder weil die erforderlichen und in der Installationsanleitung genannten freien Räume für eine adäquate Lüftung des Produkts in dem Möbel nicht vorhanden sind.
- Störungen oder Beschädigungen, hervorgerufen auf dem Transport oder beim Umsetzen des Geräts, und dessen Manipulation durch nicht autorisiertes Personal ohne Bezug zu diesem Unternehmen oder zur Marke Pando.
- Schläge, Beulen, Schrammen oder Kratzer, Glasbruch.
- Vorhandensein von Fremdkörpern, die nicht aus dem Gerät stammen, im Inneren oder Äußeren des Produkts.
- Wenn der Techniker keinen leichten Zugang zum Produkt hat, weil Elemente seinen einfachen und sicheren Zugang verwehren. Die Mittel, die von dem von Pando autorisierten Techniker für den Zugang benötigt werden, müssen vom Nutzer unter seiner Verantwortlichkeit zur Verfügung gestellt werden.
- Unsachgemäße Handhabung der äußeren elektrischen Verkabelung.
- Ästhetische, Verbrauchs- und Verschleißelemente wie Leuchtenabdeckungen, Leuchten, Tablett, Gitter, Führungen.
- Rost, Brandspuren, Flecken oder veränderter Farbton an Gehäuse, Tür, Zubehör oder Innenraum, hervorgerufen durch inadäquate Wartung oder Nutzung, oder durch den ungeschützten Kontakt mit ätzenden Elementen wie zum Beispiel nicht vom Hersteller empfohlene und inadäquate Reinigungsmittel.
- Störungen oder Beschädigungen, hervorgerufen durch Änderungen bei der elektrischen Versorgung, oder durch ungewollte und natürliche atmosphärische oder geologische Ereignisse wie Gewitter, Blitzeinschlag, Erdbeben, Überschwemmungen usw.
- Geräte aus Wiederverkauf, zweiter Hand, Änderung des ursprünglichen Eigentümers des Geräts oder von Ausstellungen, ab deren Herstellungsdatum mehr als zwei Jahre vergangen sind.

INOXPAN, S.L. ist ausdrücklich befreit von jeder Haftung bei eventuellen direkten oder indirekten Personen- oder Sachschäden, die durch eine nicht sachgemäße Handhabung des Geräts verursacht worden sind.

Kontaktdaten des autorisierten offiziellen technischen Kundendienstes Pando:

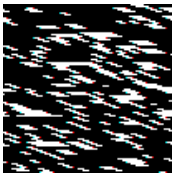
ESPAÑA, PORTUGAL Y ANDORRA:	OTROS PAÍSES:
ES www.pando.es/asistencia-tecnica/ 	EN https://www.pando.es/en/after-sales-services/ FR https://www.pando.es/fr/service-apres-vente/ 

INOXPAN S.L.

Pol. Ind. El Cros
Av. El Molí de les Mateves,11
Apdo. Correos nº 21
08310 ARGENTONA
(Barcelona - Spain)
Tel. +34 93 757 94 11
Fax +34 93 757 96 53
www.pando.es
com.pando@pando.es
Export:
export@pando.es
Tel. 902 41 55 11



Pando

www.pando.es



SERVICIO POST VENTA
España, Portugal y Andorra

www.pando.es/asistencia-tecnica/

SERVICE APRÉS VENTE
AFTER SALES SERVICE

Otros países

Autres pays / Other countries

www.pando.es/en/after-sales-services/



Certificación del Sistema de Gestión de la Calidad
Environmental Management System Certification
UNE-EN ISO 14001:2015
ES20/208675



Sistema de Gestión de la Calidad
Quality Management System
UNE-EN ISO 9001:2015
ES19/86566

