

# Operating instructions

## Washer-dryer



To avoid the risk of accidents or damage to the machine, it is **essential** to read these instructions before it is installed and used for the first time.

# Contents

---

<b>Caring for the environment</b> .....	6
<b>Warning and Safety instructions</b> .....	7
<b>Operating the washer-dryer</b> .....	15
Control panel .....	15
Display with sensor controls .....	16
Examples on how to operate the machine .....	17
Applications.....	17
<b>Before using for the first time</b> .....	18
<b>Environmentally friendly washing and drying</b> .....	21
<b>WASHING</b> .....	22
1. Prepare the laundry .....	22
2. Select a programme .....	23
3. Load the drum .....	24
4. Select programme settings .....	25
5. Add detergent.....	27
6. Start the programme .....	30
7. At the end of a programme .....	30
Spin speeds.....	31
Programme chart.....	33
Programme sequence .....	39
Special features in the programme sequence.....	40
Cottons and Minimum iron.....	41
Options .....	42
ProgrammeManager.....	42
Stains.....	43
Further options .....	43
Options - overview .....	44
Detergent.....	45
Water softeners .....	45
Miele recommended detergents .....	46
Recommended detergents in accordance with Directive (EU) No. 1015/2010...	47
Dispensing fabric conditioner and liquid starch at the end of the programme .....	48
Adding fabric conditioner or liquid starch separately.....	49
Colour run and dye removers/dyes.....	49

<b>DRYING</b> .....	50
1. Prepare the laundry .....	50
2. Select a programme .....	51
3. Load the drum .....	52
4. Select programme settings .....	53
5. Start the programme .....	54
6. At the end of a programme .....	54
Programme chart.....	55
Options .....	61
ProgrammeManager.....	61
Steam smoothing .....	61
Thermospin .....	61
Overview of options and the thermospin .....	62
<b>WASHING AND DRYING</b> .....	63
1. Prepare the laundry .....	63
2. Select a programme .....	63
3. Load the drum .....	63
4. Select programme settings .....	64
5. Add detergent.....	64
6. Programme start/finish .....	64
After each washing or drying programme .....	65
"Rinse out fluff" programme.....	65
<b>Changing the programme sequence</b> .....	66
Cancelling a programme .....	66
Interrupting a programme.....	66
To change the programme .....	66
Safety lock.....	67
Adding or removing laundry .....	68
<b>Delay start</b> .....	69
<b>Garment care label symbols</b> .....	70
<b>Cleaning and care</b> .....	71
External casing and fascia panel.....	71
Cleaning the detergent dispenser drawer .....	71
Cleaning the drum.....	72
Cleaning the water inlet filter.....	73

# Contents

---

<b>What to do if ...</b> .....	74
A programme does not start .....	74
The following fault messages appear in the display and the programme stops... ..	75
A message appears in the display at the end of the programme .....	76
General problems with the washer-dryer .....	78
An unsatisfactory wash result .....	80
Unsatisfactory drying results.....	81
The door will not open.....	82
Opening the door in the event of a blocked drain outlet and/or power cut .....	83
<b>After sales service</b> .....	85
Repairs .....	85
Guarantee: U.K. ....	85
Guarantee: Other countries .....	85
Optional accessories.....	85
<b>Installation and connection</b> .....	86
Front view .....	86
Rear view.....	87
Installation surface .....	88
Installing the washer-dryer .....	88
Remove the transit bars .....	88
Re-fitting the transit bars.....	90
Installing under a continuous worktop .....	90
Aligning the washer-dryer .....	91
The water protection system .....	92
Connection to the water supply .....	93
Water drainage .....	94
Electrical connection U.K. ....	95
<b>Miele@home</b> .....	96
Connecting the washer-dryer to your WiFi network.....	98
<b>Technical data</b> .....	99
<b>Consumption data</b> .....	100
Note for test institutes .....	101
<b>Settings</b> .....	102
Language  .....	103
Degree of soiling.....	103
Buzzer volume.....	103
Keypad tone .....	103
Code.....	103

---

Temperature unit.....	104
Display brightness.....	104
Dark display.....	104
Machine switch-off.....	104
Display maximum load.....	104
Display programme name.....	104
Memory.....	105
Pre-wash Cottons.....	105
Soak duration.....	105
Gentle action.....	105
Temperature reduction.....	106
Water plus.....	106
Water plus level.....	106
Maximum rinse level.....	106
Suds cooling.....	107
Low water pressure.....	107
Distribution controller.....	107
Drying levels.....	107
Miele@home.....	108
Remote control.....	108
SmartGrid.....	109
<b>Optional accessories.....</b>	<b>110</b>
Detergent.....	110
Specialist detergents.....	110
Fabric care.....	111
Additives.....	111

# Caring for the environment

---

## Disposal of the packing material

The packaging is designed to protect the appliance from damage during transportation. The packaging materials used are selected from materials which are environmentally friendly for disposal and should be recycled.

Recycling the packaging reduces the use of raw materials in the manufacturing process and also reduces the amount of waste in landfill sites.

## Disposing of your old appliance

Electrical and electronic appliances often contain valuable materials. They also contain specific materials, compounds and components, which were essential for their correct function and safety. These could be hazardous to human health and to the environment if disposed of with your domestic waste or if handled incorrectly. Please do not, therefore, dispose of your old appliance with your household waste.



Please dispose of it at your local community waste collection / recycling centre for electrical and electronic appliances, or contact your dealer or Miele for advice. You are also responsible (by law, depending on country) for deleting any personal data that may be stored on the appliance being disposed of. Please ensure that your old appliance poses no risk to children while being stored prior to disposal.

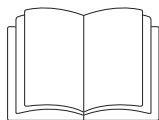

- ▶ It is **essential** to read these instructions.

This washer-dryer complies with current safety requirements. Inappropriate use can, however, lead to personal injury and damage to property.

To protect yourself and to avoid the risk of damage to the washer-dryer, please read these instructions carefully before using it for the first time. They contain important information on its safety, use and maintenance.

Keep these instructions in a safe place and pass them on to any future owner.

### Correct application

- ▶ This washer-dryer is intended for use in domestic households and similar working and residential environments.
- ▶ This washer-dryer is intended for use in domestic households for the following applications only:
  - washing textiles which have a care label stating that they are washable.
  - drying textiles which have been washed in water and have a care label stating that they are suitable for tumble drying.

Any other usage is not permitted. Miele cannot be held liable for damage resulting from improper use or incorrect operation of the machine.

- ▶ This washer-dryer is not intended for outdoor use.

## Warning and Safety instructions

---

▶ This washer-dryer can only be used by people with reduced physical, sensory or mental capabilities, or lack of experience or knowledge, if they are supervised whilst using it or have been shown how to use it in a safe way and understand and recognise the consequences of incorrect operation.

### Safety with children

▶ Children under eight years of age must be kept away from the washer-dryer unless they are constantly supervised.

▶ Children eight years and older may only use the washer-dryer unsupervised if they have been shown how to use it safely and recognise and understand the consequences of incorrect operation.

▶ Children must not be allowed to clean or maintain the washer-dryer unsupervised.

▶ Please supervise children in the vicinity of the washer-dryer and do not let them play with it.

### Technical safety

▶ Before setting up the washing-dryer, check it for any externally visible damage.

Do not install or use a damaged washer-dryer.

▶ Before connecting the washer-dryer, ensure that the connection data on the data plate (fuse rating, voltage and frequency) match the mains electricity supply. If in any doubt, consult a qualified electrician.



## Warning and Safety instructions

---

▶ The electrical safety of this washer-dryer can only be guaranteed when correctly earthed.

It is essential that this standard safety requirement is met. If in any doubt, please have the household wiring system tested by a qualified electrician.

Miele cannot be held liable for the consequences of an inadequate earthing system (e.g. electric shock).

▶ Do not connect the machine to the mains electricity supply by an extension lead, multi-socket adapter or similar. These can overheat and are a fire hazard.

▶ Unauthorised repairs could result in unforeseen dangers for the user, for which the manufacturer cannot accept liability. Repairs should only be undertaken by a Miele authorised service technician, otherwise any subsequent damage will not be covered by the guarantee.

▶ Please observe the instructions in "Installation and connection" and the "Technical data".

▶ This washer-dryer is supplied with a special lamp to cope with particular conditions (e.g. temperature, moisture, chemical resistance, abrasion resistance and vibration). This special lamp must only be used for the purpose it is intended for. It is not suitable for room lighting. Replacement lamps may only be fitted by a Miele authorised person or by Miele Service.

▶ The electrical socket must be easily accessible after installation so that the washer-dryer can be disconnected from the electricity supply if necessary.

## Warning and Safety instructions

---

- ▶ The washer-dryer must be isolated from the electricity supply when cleaning and maintaining the machine and in the event of a fault.
- ▶ The Miele "Water protection system" protects from water damage provided the following conditions are met:
  - The machine is correctly plumbed in and connected to the electricity supply.
  - If a fault or damage has been identified, the washer-dryer must be examined by a competent person before further use, and repaired if necessary.
- ▶ The water flow pressure must be at least 100 kPa and should not exceed 1000 kPa.
- ▶ Faulty components must only be replaced by genuine Miele original spare parts. Only when these parts are fitted can Miele guarantee the safety standards of the machine.
- ▶ If the electrical connection cable is faulty it must only be replaced by a Miele authorised service technician to protect the user from danger.
- ▶ This washer-dryer must not be used in a non-stationary location (e.g. on a ship).
- ▶ Do not make any alterations to the washer-dryer, unless authorised to do so by Miele.
- ▶ Reliable and safe operation of this washer-dryer can only be assured if it has been connected to the mains electricity supply.

### Correct use

- ▶ Do not install the washer-dryer in a room where there is a risk of frost. Frozen hoses may burst or split. The reliability of the electronic control unit may be impaired at temperatures below freezing point.
- ▶ Before using the machine for the first time, check that the transit bars at the rear of the washer-dryer have been removed (see "Installation and connection - Removing the transit bars"). During spinning, a transit bar which is still in place may result in damage to both the washer-dryer and adjacent furniture or appliances.
- ▶ Turn off the stopcock if the washer-dryer is to be left for any length of time (e.g. holiday), especially if there is no floor drain (gully) in the immediate vicinity.
- ▶ Flooding danger. If hooking the drain hose into a wash basin, check that the water can drain off quickly enough to prevent the sink from overflowing. Make sure the drain hose is secure, so that the force of the water flowing out of the hose does not dislodge it.
- ▶ Take care to ensure that foreign objects (e.g. nails, pins, coins, paper clips) do not find their way into the machine with the laundry. These may damage components of the machine (e.g. suds container, drum), which in turn can result in damage to the laundry.
- ▶ Do not leave any detergent dispensing aids, e.g. plastic dispenser balls, in the laundry when tumble drying. These dispensers can melt during the drying programme and cause damage to the washer-dryer and the laundry.
- ▶ Caution, the metal cap located on the inside of the door glass is very hot after drying. Open the drum door fully after drying. Do not touch the metal cap. Danger of burning!

## Warning and Safety instructions

---

- ▶ Fabric conditioner and similar products must be used according to the instructions on the manufacturer's packaging.
- ▶ If the correct amount of detergent is dispensed, the washer-dryer should not need to be descaled. If, however, there is large build-up of limescale and you need to descale it, you must use a special non-corrosive descaling agent. A suitable descaling agent is available to order from Miele (see "Optional accessories"). Instructions on the packaging must be strictly observed.
- ▶ To prevent the risk of fire, the following textiles **must not** be dried:
  - Items which have not been washed.
  - Items, such as workwear, which have not been thoroughly washed and which are still soiled with grease, oil or other deposits (such as cooking oil, cosmetics, lotions etc). If items have not been thoroughly washed there is a danger that these might ignite when heated, even after they have been removed from the washer-dryer at the end of the programme.
  - Items (e.g. mops and floor cloths) which have been treated with inflammable cleaning agents or which contain residues of acetone, alcohol, benzene, petrol, stain remover, turpentine, wax and wax remover or other chemicals.
  - Items which have been splashed with hair lacquer, hair spray, nail varnish remover or similar substances.

When washing heavily soiled items ensure that you use sufficient detergent and select a high temperature. If in doubt, wash the items several times.

## Warning and Safety instructions

---

- ▶ To prevent the risk of fire, the following textiles must not be tumble dried:
  - Items which have been cleaned using chemicals (e.g. professional dry-cleaning agents).
  - Items which contain a large proportion of rubber, foam rubber or rubber-like materials. For example, products made from latex foam rubber, shower caps, waterproof textiles, rubberised articles and items of clothing and pillows with foam rubber filling.
  - Damaged items which contain padding or fillings (e.g. pillows, jackets). When damaged, the filling can get out with the risk of it igniting.
- ▶ Only use dyes specified by the manufacturer as being suitable for use in a domestic washing machine. These must only be used in domestic quantities. Always observe the manufacturer's instructions carefully.
- ▶ Colour run and dye removers contain sulphur compounds which can cause corrosion. Do not use these products in this washer-dryer.
- ▶ In many programmes, the heating phase is followed by a cooling down phase to ensure that the items are not too hot to handle when you remove them (this also avoids the danger of the laundry self-igniting). The programme is not finished until the cooling down phase has been completed. As soon as the programme has finished, remove all laundry from the drum.
- ▶ Warning: do not switch the washer-dryer off before the drying programme has finished. If this is done, the laundry must be removed immediately and hung up or spread out to cool it down.
- ▶ Textiles which have been pre-treated in solvent based cleaning agents must be thoroughly rinsed in clean water before being washed in the machine.

## Warning and Safety instructions

---

- ▶ Do not use solvent based cleaning agents, e.g. those containing benzene, in this washer-dryer, as this may result in damage to component parts and create toxic fumes. Such agents also pose a fire and explosion hazard.
- ▶ If detergent comes into contact with the eyes, rinse them thoroughly with lukewarm water immediately. If swallowed, seek medical assistance immediately and retain the packaging or label for reference. Those with skin problems or sensitive skin should avoid their skin coming into contact with detergent.
- ▶ The maximum load for this washer-dryer is 7.0 kg (dry weight) for washing and 4.0 kg (dry weight) for tumble drying. See the "Programme chart" for the maximum recommended loads for individual programmes.
- ▶ Take care when opening the drum door after using the steam function. Danger of burning due to escaping steam and the high temperature of the surface of the drum as well as the porthole glass. Stand back away from the machine and wait until the steam has dissipated.

### Accessories

- ▶ Accessory parts may only be fitted when expressly approved by Miele. If other parts are used, guarantee, performance and product liability claims will be invalidated.
- ▶ If you order a plinth for this washer-dryer (available from Miele as an optional accessory), make sure it is the correct one.

Miele cannot be held liable for damage caused by non-compliance with these Warning and Safety instructions.

## Control panel

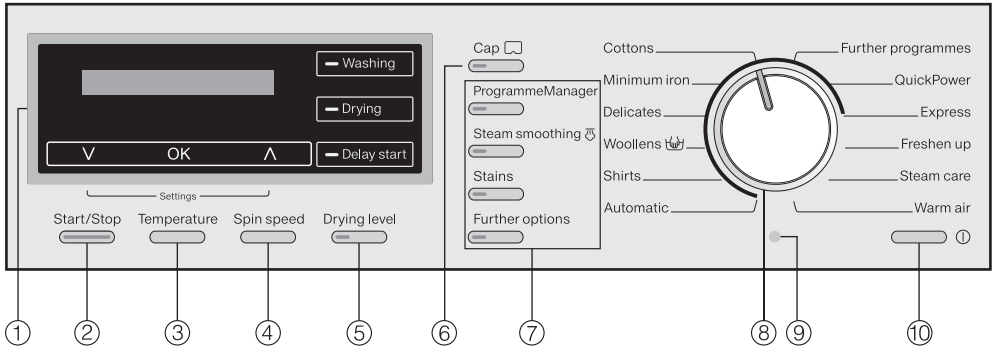

① **Display with sensor controls**

See the next page for more information.

② **Start/Stop button**

For starting the programme selected and cancelling a programme once it has started.

③ **Temperature button**

For selecting the temperature.

④ **Spin speed button**

For selecting the spin speed.

⑤ **Drying level button**

For selecting the drying level.

⑥ **CapDosing button**

For selecting CapDosing

⑦ **Options buttons**

Various options can be added to the programmes.

⑧ **Programme selector**

For selecting washing and drying programmes.

⑨ **Optical interface**

For service technicians.

⑩ **⏻ button**

For switching the washer-dryer on and off. To save energy the washer-dryer will switch off automatically 15 minutes after the end of the programme/anti-crease phase or after being switched on if no other selection is made.

# Operating the washer-dryer

## Display with sensor controls

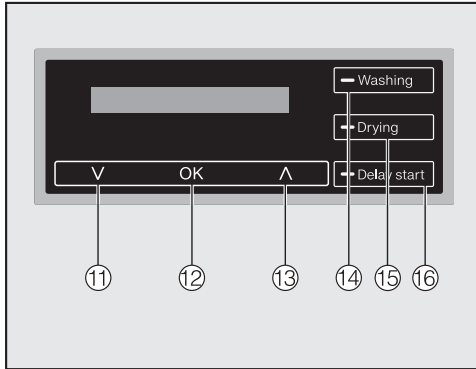

- ⑪ **∇ sensor**  
Scrolls down the list to the next option or decreases a value.
- ⑫ **OK sensor**  
Confirms the programme selected, a value set or opens a sub-menu.
- ⑬ **∧ sensor**  
Scrolls up the list to the next option or increases a value.
- ⑭ **Washing sensor**  
For selecting the washing function
- ⑮ **Drying sensor**  
For selecting the drying function
- ⑯ **Delay start sensor**  
For selecting delay start

## Standard display

The standard display for a wash programme shows the following values from left to right:

2:59      60°C      1600

- the programme duration
- the selected wash temperature
- the selected spin speed

The standard display for a drying programme shows the following values from left to right:

1:30      Normal      1600

- the programme duration
- the drying level selected (only briefly)
- the spin speed selected for the thermo-spin (if applicable for the programme being used)

The standard display of a continuous programme for washing followed by drying shows the following:

- the programme duration
- the drying level selected (only briefly)
- the selected wash temperature
- the selected spin speed

**Tip:** The illuminated ∇ and ∧ arrow sensors can be used to see the drying level selected.





## Examples on how to operate the machine

### Scrolling through a list

The  arrows in the display indicate that choices are available:



Touching the  sensor scrolls down the list to the next option and touching the  sensor scrolls up the list to the next option. The *OK* sensor is used to activate the option which is currently in the display.



### Identifying options selected



An option which has been activated will have a tick  next to it.

### Setting numerical values



The numerical value is highlighted in white. Touching the  sensor decreases the value and touching the  sensor increases it. The *OK* sensor is used to activate the value shown in the display.

### Exiting a sub-menu

Select *Back*  to exit a sub-menu.

## Applications

You can use this washer-dryer to:

- **wash separately**  
Maximum load (depending on programme) 7.0 kg;
- **dry separately**  
Maximum load (depending on programme) 4.0 kg;  
or
- **wash and dry in a continuous sequence**  
Maximum load (depending on programme) 4.0 kg.

## Before using for the first time

---

### Remove the drain hose elbow from the drum

An elbow piece for the drain hose is stored in the drum.

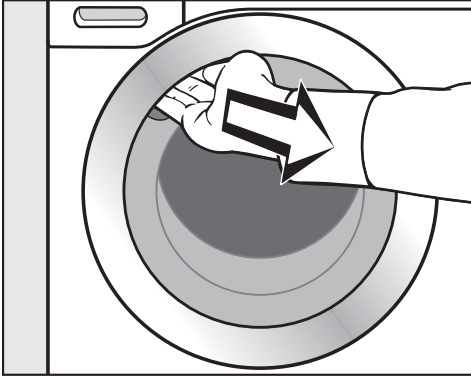

- Reach under the door grip and pull the door open.
- Remove the elbow piece.

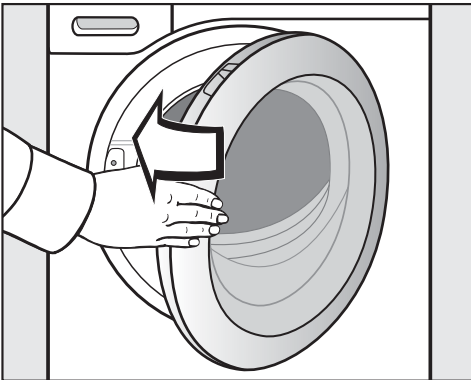

- Shut the door with a gentle swing.

### Remove the protective foil and stickers

- Remove
  - the protective foil from the door.
  - any stickers from the front and the lid.

 Please do not remove any labels (e.g. the data plate), visible when you open the door.

## Before using for the first time

 Before using the washer-dryer for the first time ensure that it is correctly installed and connected. See "Installation and connection". Also check that the drain filter is securely tightened to prevent the risk of water leaks during use.

This washer-dryer has undergone a complete functional test at the factory and there will be some residual water in the drum from this process.

### Switch the washer-dryer on



- Press the  button.

The welcome screen will light up.

### Select the language

You will be asked to select the language you want for the display. It is possible to change the language at any time via "Settings".

deutsch  

- Touch the  or  sensor until the language you want appears in the display.
- Confirm your selection of the language by touching the *OK* sensor.

### Miele@home

The display indicates that this washer-dryer can be connected to the Miele@home system via a communication module (only available in selected countries).

- Confirm the message in the display with *OK*.

### Remove the transit bars

A reminder to remove the transit bars will appear in the display.

 Failure to remove the transit bars can result in damage to the washer-dryer and to adjacent cabinetry or appliances.

Remove the transit bars as described in "Installation and connection".

- After removing the transit bars (if this has not already been done by your fitter) confirm by pressing the *OK* button.

## Before using for the first time

### Start the calibration programme

The following message will in the display:

**i** Open  and run Cottons 90°C without laundry.

- Touch the  $\nabla$  sensor repeatedly until you have read all the rows of text.

The OK sensor will light up.

- Confirm the message with the OK sensor.

It is important to calibrate the machine to ensure optimum water and energy usage, as well as optimum washing and drying results.

To do this the *Cottons 90 °C* programme **must** be run without laundry and without detergent.

No other programmes can be started until calibration has been carried out.

- Open the stopcock.
- Turn the programme selector to *Cottons*.

**Do not** change any other programme settings.

1:55 90°C 1600

- Press the *Start/Stop* button.

The calibration programme will start.

At the end of the programme the following message will appear in the display:

**i** Set-up complete

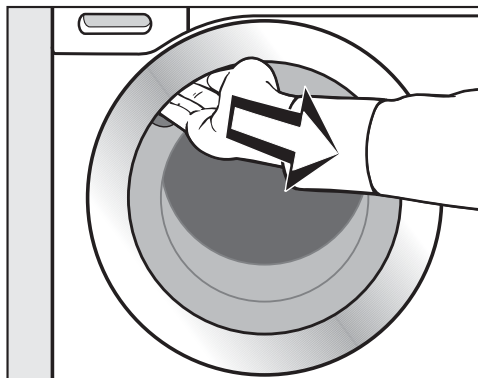

- Reach under the door grip and pull the door open.

**Tip:** Leave the door slightly open to allow the drum to dry.

- Switch the washer-dryer off with the  button.

# Environmentally friendly washing and drying

---

## Energy and water consumption

- Water consumption and energy usage are determined by the size of the load. To make the most of your machine, load the maximum dry load for the programme you are using.
- Use the *Express* programme for small, lightly soiled loads.
- When smaller amounts of laundry are washed, the automatic load recognition system will reduce the amount of water and energy used.
- Modern detergents make it possible to wash at lower temperatures (e.g. 20 °C). Washing using lower temperature settings will save energy.
- To maintain the hygiene of the washer-dryer we recommend running a washing programme with a temperature of 60 °C or above. Hygiene info will appear in the display to remind you to do this.

## Detergent

- Do not exceed the amounts of detergent recommended by the manufacturer on the packaging.
- Adjust the dosage to the degree of soiling of the laundry.
- Reduce the amount of detergent with smaller loads (approx. 1/3 less than the amount recommended can be used when washing a half load).

## When drying with a tumble dryer

To save energy when tumble drying, select the highest possible spin speed for the wash programme and for the thermo-spin.

# WASHING

## 1. Prepare the laundry

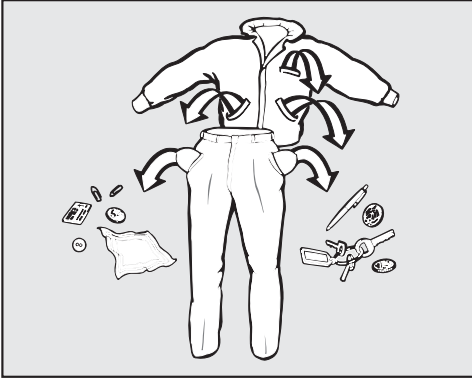

- Empty all pockets.

⚠ Foreign objects (e.g. nails, coins, paper clips, etc.) can cause damage to garments and to components in the machine.

Check the laundry before washing and remove any foreign objects.

### Sort the laundry

- Sort the laundry by colour and by care label. Most garments have a textile care label in the collar or side seam.

**Tip:** Dark textiles often contain excess dye and should be washed separately several times before being included in a mixed load. Always wash whites and coloureds separately.

### Pre-treat stains

- Badly soiled areas, stains etc. should be cleaned as soon as possible, preferably whilst still fresh. Spillages should be carefully dabbed off using a soft, colourfast cloth. Do not rub.

**Tip:** Badly soiled areas can be pre-treated with liquid detergent, stain removers etc. first, following the manufacturer's instructions. With particularly stubborn stains ask your dry cleaner for advice.

⚠ Solvent-based cleaners (e.g. benzene) can damage plastic parts. When pre-treating garments, make sure that any plastic parts (e.g. buttons) are protected from cleaning agent.

⚠ Do not use solvent-based cleaning agents in or on this washer-dryer.

### General tips

- Curtains: Remove lead weights first or place in a laundry bag.
- Underwiring and collar stiffeners: Any loose wiring in bras, shirt collar stiffeners, etc. should be removed or sewn in.
- Close any zips, attach velcro fasteners, fasten hooks and eyes etc. before washing.
- Wash whites and coloureds separately.
- Fasten duvet covers, pillow cases etc. to prevent small items from being rolled up inside them.

Do not machine wash items which are specified by the manufacturer as **not washable** on the care label (☒ symbol).

## 2. Select a programme

### Switch the washer-dryer on

- Press the  button.

The interior drum lighting will come on.

The drum lighting will go out automatically after five minutes.

### Select a programme

- with the programme selector dial

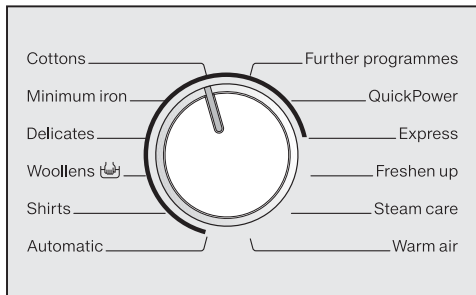

- Turn the programme selector to the required programme.

The maximum load for the programme selected will appear in the display. This will then be replaced by the standard display.

- with the programme selector dial set to the "Further programmes" position

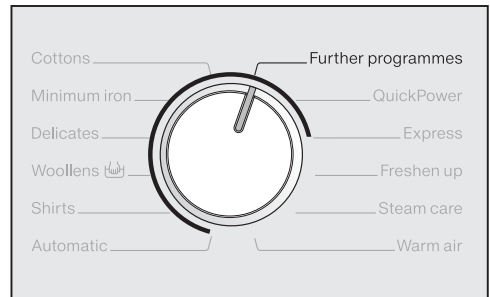

- Turn the programme selector to *Further programmes*.

The following will appear in the display:



- Touch the  $\nabla$  or  $\blacktriangle$  sensor until the programme you want appears in the display.
- Confirm the programme with the *OK* sensor.

The maximum load for the programme selected will appear in the display. This will then be replaced by the standard display.

The *Drying* indicator light must **not** be lit up, as this would mean that the washing programme would be followed immediately by the relevant drying programme.

# WASHING

## 3. Load the drum

Open the door

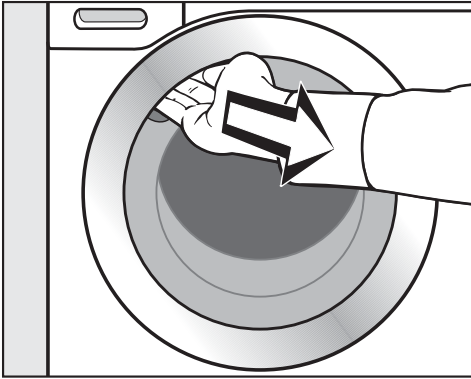

- Reach under the door grip and pull the door open.

Check the drum for pets or foreign objects before loading it with laundry.

- Unfold the laundry and load loosely into the drum.

Mixing both large and small items gives better wash results and also helps distribute the load evenly during spinning.

The most efficient use of energy and water is achieved when a full load is washed. However, do not overload as this reduces cleaning efficiency and causes creases.

Close the door

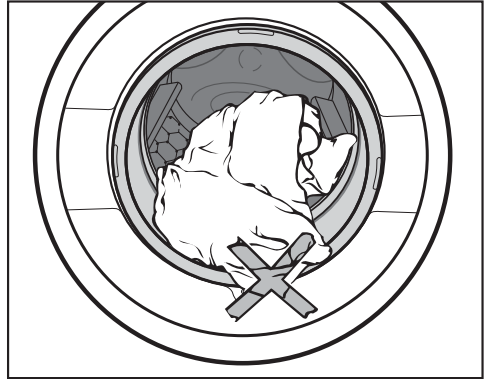

- Make sure that no items are caught between the door and the seal.

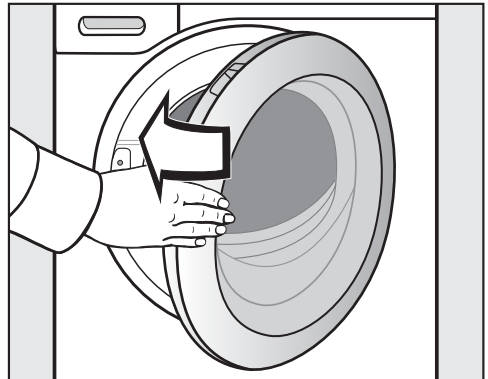

- Shut the door with a gentle swing.

The display will ask you to enter the degree of soiling of the laundry.



## 4. Select programme settings

### Select the degree of soiling

#### Lightly soiled

No visible dirt or stains. Possibly slight body odour.

#### Normally soiled

Visibly dirty and/or just a few slight stains.

#### Heavily soiled

Soiling and/or stains clearly visible.

The following will appear in the display:



- Select the degree of soiling with the  $\nabla$  or  $\blacktriangle$  sensor and confirm with *OK*.

The following parameters will change depending on the degree of soiling selected:

- detergent dosage
- rinse water level
- with light soiling the programme duration will be reduced
- with heavy soiling, a pre-wash will be carried out automatically with some programmes.

**Tip:** You can alter the default setting for the degree of soiling or switch off the degree of soiling query in Settings (see "Settings - Degree of soiling").

# WASHING

## Select a temperature

You can alter the pre-set temperature of a wash programme.

- Press the *Temperature* button.

The following will appear in the display:

Temperature 60 °C

- Set the temperature you want with the  $\nabla$  and  $\wedge$  sensors and confirm your selection with the *OK* sensor.

## Select the spin speed

You can alter the pre-set spin speed of a wash programme.

- Press the *Spin speed* button.

The following will appear in the display:

Spin speed 1600 rpm

- Set the spin speed you want with the  $\nabla$  and  $\wedge$  sensors and confirm your selection with the *OK* sensor.

## Select options

You can use the extra options to augment the wash programmes.

ProgrammeManager



Steam smoothing  $\overline{\text{S}}$



Stains



Further options



- Options are selecting using the *ProgrammeManager*, *Steam smoothing*, *Stains* or *Further options* buttons.

The indicator light in the button will come on.

You can only select options which are compatible with the washing programme being used (see "WASHING", "Options").

## Select delay start

You can use delay start to set the finish time or the start time for a programme.

- Select a delay start time if required.

Please see "Delay start" for more information.

## 5. Add detergent

Detergent is dispensed either via the detergent drawer (A) or with Cap dosing (B).

### (A) Detergent dispenser drawer

Too little detergent results in:

- Laundry not getting properly clean and with time it may become grey and hard to the touch.
- Greasy particles clinging to laundry.
- Limescale deposits on the heater elements.

Too much detergent results in:

- Excessive foam which causes a low level of agitation and poor wash, rinse and spin results.
- High water consumption (an additional rinse cycle will automatically switch in).
- A burden to the environment.

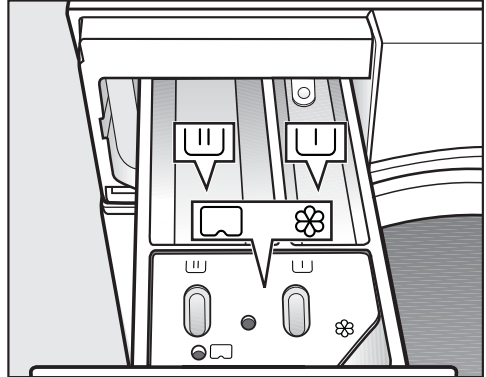

- Pull out the detergent dispenser drawer and add detergent to the compartments as follows:



Detergent for the pre-wash (divide the total recommended amount as follows:  $\frac{1}{3}$  to compartment (U) and  $\frac{2}{3}$  to compartment (U))



Detergent for the main wash, including Soak, if selected



Fabric conditioner, liquid starch or capsules.

See "WASHING", "Detergent" for further information about detergents and how much to dispense.

# WASHING

## Ⓑ CapDosing

Three different types of capsule are available:

- ☼ = Fabric care (e.g. fabric conditioner, proofing agent)
- 🧴 = Additives (e.g. detergent enhancers)
- 💧 = Detergent (for the main wash only)

Each capsule contains the correct amount for one wash cycle.

Caps are available to order from Miele or from the Miele Webshop (see the end of this booklet for contact details).

⚠ Keep capsules out of the reach of children.

### Activating CapDosing

- Press the *Cap* 🗨 button.

The first type of capsule which can be selected for the programme will appear in the display.

💧 Cap

- Select the type of cap you want with the ∨ and ∧ sensors and confirm your selection with the *OK* sensor.

## Inserting a capsule

- Open the detergent dispenser drawer.

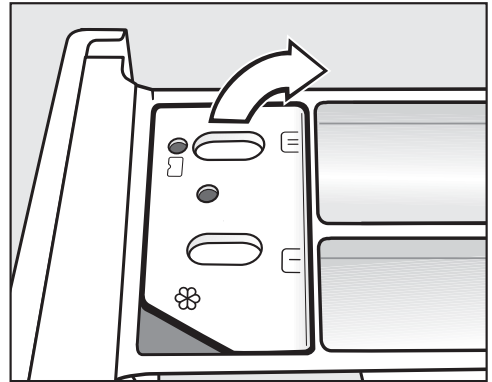

- Open the lid of the ☼/🗨 compartment.

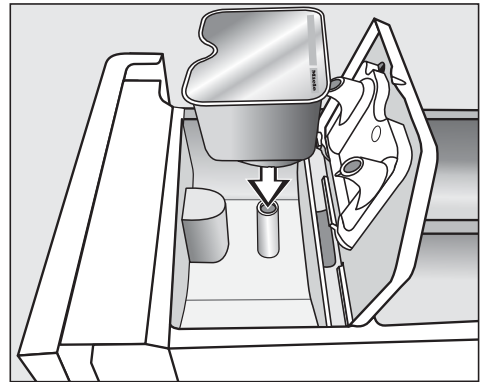

- Press the capsule in firmly.

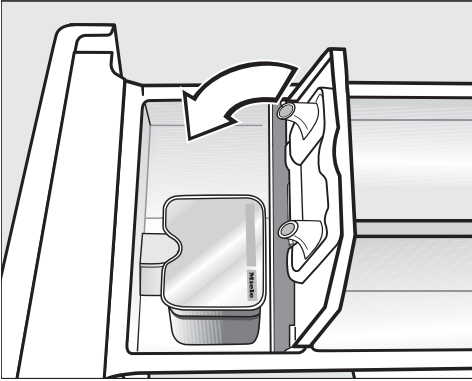

- Remove the empty capsule at the end of the programme.

For technical reasons a small amount of water will remain in the capsule.



## Deactivating/changing CapDosing

- Touch the Cap  sensor and follow the instructions in the display.

- Close the lid and press it firmly shut.
- Close the detergent dispenser drawer.

The capsule is opened by the act of inserting it in the detergent dispenser drawer. The contents can run out of the capsule if you then remove it from the drawer before it is used. In this case, dispose of the capsule and do not re-use it.

The wash programme will dispense the contents of the capsule at the correct time.

Water intake to the  compartment is solely via the capsule. When using capsules do not add fabric conditioner to the  compartment.

# WASHING

## 6. Start the programme

- Press the flashing *Start/Stop* button.

The door will lock (the  symbol will appear in the display to show this) and the programme will start.

The programme status will appear in the display.



The washer-dryer will keep you updated on the programme status and the time remaining for the programme to run.

If a delay start time has been selected, this will count down in the display until the programme starts.

The drum lighting switches off once the programme has started.

## 7. At the end of a programme

The door is still locked during the anti-crease phase and the following will appear alternately in the display:



- Press the *Start/Stop* button.

The door will unlock.

The door unlocks automatically at the end of the anti-crease phase.

- Pull open the door.
- Unload the drum.

Items left in the drum could discolour other items in the next wash or become discoloured themselves. Check that all items have been removed from the drum.

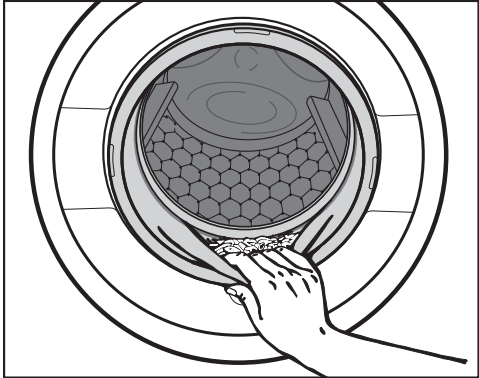

- Check the folds in the door seal for any small articles, e.g. buttons, which might be lodged there.

**Tip:** Leave the door slightly open to allow the drum to dry.

- Switch the washer-dryer off with the  button.
- If applicable, remove the used capsule from the detergent dispensing drawer.

**Tip:** Leave the detergent dispenser drawer slightly open to allow it to dry.

## Spin speeds

Programme	rpm
Cottons	1600
Minimum iron	1200
Delicates	900
Woollens	1200*
Shirts	900
Automatic	1400
QuickPower	1600
Express	1200
Denim	900
Dark garments	1200
Outerwear	800
Proofing	1000
Sportswear	1200
Trainers	800
Silks	600*
Down filled items	1200
Curtains	600
Pillows	1200
Cottons hygiene	1600
Drain / Spin	1600
Separate rinse / Starch	1600*

## Final spin speed in the programme

When a programme is selected the optimum spin speed for that programme will appear in the display. For programmes marked with a \* in the chart, the optimum spin speed is not the maximum spin speed.

The final spin speed can be reduced. However, you cannot select a final spin speed higher than that shown in the chart.

## Interim spin

There is a spin after the main wash and between the rinses. A reduction in the final spin speed will also reduce the interim spin speed. If a spin speed of less than 700 rpm is selected for the *Cottons* programme, an additional rinse is introduced.

# WASHING

---

## To omit the final spin (Rinse hold)

- Use the *Spin speed* button to select the  (rinse hold) setting.

The laundry is not spun after the final rinse and remains in the final rinse water. This helps prevent creasing if the laundry is not going to be removed from the drum immediately after the end of the programme.

## To start the final spin:

- Use the *spin speed* button to select the required spin speed and confirm your choice with *OK*.

The laundry will be spun at the speed you have set.

or

- Start the final spin with the *Start/Stop* button.

The laundry will be spun at the maximum spin speed for the selected wash programme.

## To end the programme:

- Use the *spin speed* button to select the 0 rpm setting (without spin) and confirm your choice with *OK*.

The water will drain away.

## To omit rinse and interim spin and the final spin

- Press the *Spin speed* button.
- Select the 0 rpm setting.

After the last rinse, the water will be pumped away and the anti-crease phase will switch in.

In some programmes an additional rinse is introduced with this setting.



## Programme chart

<b>Cottons</b>		<b>cold to 90°C</b>	<b>Max. load 7.0 kg</b>
Use for	Cotton, linen or mixed fibre fabric, e.g. table linen, towelling, underwear, T-shirts etc.		
Note	<p>The settings 60 °C/40 °C differ from <math>\langle 60^{\circ}\text{C} \rangle / \langle 40^{\circ}\text{C} \rangle</math> as follows:</p> <ul style="list-style-type: none"> <li>– Shorter programme durations</li> <li>– Longer temperature holding times</li> <li>– Higher energy consumption</li> </ul> <p>Where a higher degree of cleanliness is required use the <i>Cottons hygiene</i> programme.</p>		
<b>Note for test institutes:</b> Test programme in accordance with EN 60456			
<b>Minimum iron</b>		<b>cold to 60°C</b>	<b>Max. load 3.5 kg</b>
Use for	Synthetic and mixed fibre fabric and easy care cotton.		
Note	Reduce the spin speed for fabric which creases easily.		
<b>Delicates</b>		<b>cold to 60°C</b>	<b>Max. load 2.0 kg</b>
Use for	Delicate garments made from synthetic fibre, mixed fibre, rayon and viscose.		
Note	Deselect the spin for items which crease easily.		
<b>Woollens</b> 		<b>cold to 40°C</b>	<b>Max. load 2.0 kg</b>
Use for	Machine-washable or hand-washable wool or wool blend fabric. If the care label does not specify a temperature, wash using the cold setting.		
Note	Reduce the spin speed for items which crease easily.		

# WASHING

<b>Shirts</b>		<b>cold to 60°C</b>	<b>Max. load 1.0 kg/2.0 kg</b>
Use for	Shirts and blouses made of cotton and mixed fibre.		
Note	<ul style="list-style-type: none"> <li>– Pre-treat soiled cuffs and collars if necessary.</li> <li>– Turn shirts and blouses inside out, do up buttons and turn collars and cuffs inwards.</li> <li>– Wash silk shirts and blouses in the <i>Silks</i>  programme.</li> <li>– If the pre-set <i>Steam smoothing</i> option is switched off, the maximum load capacity is increased to 2.0 kg.</li> </ul>		
<b>Automatic</b>		<b>cold to 40°C</b>	<b>Max. load 5.0 kg</b>
Use for	Mixed loads of garments suitable for the <i>Cottons</i> and <i>Minimum iron</i> programmes.		
Note	The wash parameters (e.g. water level, wash rhythm and spin speed) are adjusted automatically in this programme to ensure the best possible care and wash result for each item.		
<b>QuickPower</b>		<b>60 °C to 40 °C</b>	<b>Max. load 4.0 kg</b>
Use for	Normally soiled garments which are also suitable for washing in the <i>Cottons</i> programme.		
Note	A special saturation process and wash rhythm ensure that the laundry is cleaned particularly quickly and thoroughly.		
<b>Express</b>		<b>cold to 40°C</b>	<b>Max. load 3.5 kg</b>
Use for	Cotton garments that have hardly been worn or are only very lightly soiled.		
<b>Freshen up</b>	⇨ "Programme chart - DRYING"		
<b>Steam care</b>	⇨ "Programme chart - DRYING"		
<b>Timed drying warm air</b>	⇨ "Programme chart - DRYING"		

## Further programmes

<b>Denim</b>		<b>cold to 60°C</b>	<b>Max. load 3.0 kg</b>
Note	<ul style="list-style-type: none"> <li>– Wash denim inside-out.</li> <li>– Denim often contains excess dye and may run during the first few washes. Wash light and dark coloured items separately.</li> <li>– Close any zips, do up buttons etc. before washing.</li> </ul>		
<b>Dark garments</b>		<b>cold to 60°C</b>	<b>Max. load 3.0 kg</b>
Use for	Black and dark items made of cotton or mixed fibres.		
Note	Wash inside out.		
<b>Outerwear</b>		<b>cold to 40°C</b>	<b>Max. load 2.5 kg</b>
Use for	Outerwear made from membrane fabrics such as Gore-Tex <sup>®</sup> , SYMPATEX <sup>®</sup> , WINDSTOPPER <sup>®</sup> etc.		
Note	<ul style="list-style-type: none"> <li>– Zip up or close jackets before washing.</li> <li>– Do not use fabric conditioner.</li> <li>– If wished, these garments can also be re-proofed using the <i>Proofing</i> programme. Proofing should not be done every time the garment is washed.</li> </ul>		
<b>Proofing</b>		<b>40 °C</b>	<b>Max. load 2.5 kg</b>
Use for	Treating microfibre fabric, skiwear and table linen made from mainly synthetic fibres to provide a water and dirt resistant finish.		
Note	<ul style="list-style-type: none"> <li>– The items should be freshly laundered and spun or dried before proofing.</li> <li>– For best results, the items should be heat-treated afterwards either by tumble drying or by ironing.</li> </ul>		

# WASHING

<b>Sportswear</b>		<b>cold to 60°C</b>	<b>Max. load 2.5 kg</b>
Use for	Sportswear such as singlets and leggings as well as microfibre and fleece garments.		
Note	<ul style="list-style-type: none"> <li>– Do not use fabric conditioner.</li> <li>– Observe the manufacturer's care label.</li> </ul>		
<b>Trainers</b>		<b>cold to 40°C</b>	<b>Max. 2 pairs</b>
Use for	Sports shoes only (not leather shoes).		
Note	<ul style="list-style-type: none"> <li>– Manufacturer's care label must be observed.</li> <li>– Do not use fabric conditioner.</li> <li>– Coarse soiling should be brushed off first.</li> <li>– A pre-rinse without detergent is carried out automatically to remove dust.</li> </ul>		
<b>Silks </b>		<b>cold to 30°C</b>	<b>Max. load 1.0 kg</b>
Use for	Silks and other handwashable fabric with no wool content.		
Note	Place tights, bras etc. in a laundry bag.		
<b>Down filled items</b>		<b>cold to 60°C</b>	<b>Max. load 2.5 kg</b>
Use for	Jackets, sleeping bags, pillows and other down-filled items.		
Note	<ul style="list-style-type: none"> <li>– Remove air from the items before washing to prevent an excessive build-up of foam. To do this either push the items into a narrow laundry bag to compress them or tie the items together with a washable strap.</li> <li>– Observe the instructions on the wash care label.</li> </ul>		







































# WASHING

<b>Curtains</b>		<b>cold to 40°C</b>	<b>Max. load 2.0 kg</b>
Use for	Curtains specified as machine-washable by the manufacturer.		
Note	<ul style="list-style-type: none"> <li>– Select the <i>pre-wash</i> option to remove dust.</li> <li>– For curtains which crease easily, reduce the spin speed or deselect the spin.</li> <li>– Remove weights from curtains.</li> </ul>		
<b>Pillows</b>		<b>cold to 60°C</b>	<b>2 pillows (40 x 80 cm) or 1 pillow (80 x 80 cm)</b>
Use for	Synthetic filled washable pillows.		
Note	<ul style="list-style-type: none"> <li>– Remove air from the items before washing to prevent an excessive build-up of foam. To do this either push the items into a narrow laundry bag to compress them or tie the items together with a washable strap.</li> <li>– Observe the instructions on the wash care label.</li> </ul>		
<b>Cottons hygiene</b>		<b>90 °C to 60 °C</b>	<b>Max. load 7.0 kg</b>
Use for	Cotton or linen with direct skin contact or for which special hygiene requirements apply, e.g. underwear, bed linen, encasing products		
Note	Observe the instructions on the wash care label.		
<b>Drain / Spin</b>			<b>Max. load 7.0 kg</b>
Note	<ul style="list-style-type: none"> <li>– Drain only: Select 0 rpm for the spin speed.</li> <li>– Make sure you select the appropriate spin speed.</li> </ul>		

# WASHING

<b>Separate rinse / Starch</b>		<b>Max. load 7.0 kg</b>
Use for	<ul style="list-style-type: none"> <li>– Hand washed items which only need rinsing</li> <li>– Table cloths, serviettes and workwear which require starching.</li> </ul>	
Note	<ul style="list-style-type: none"> <li>– Reduce the spin speed for items which crease easily.</li> <li>– The laundry should be washed but not treated with fabric conditioner.</li> <li>– Items will be rinsed very effectively using two rinse cycles by activating the <i>Water plus</i> option. The <i>Extra rinse</i> setting needs to be activated for the <i>Water plus</i> option. See "Settings".</li> </ul>	
<b>Timed drying Cool air</b> ⇨ "Programme chart - DRYING"		
<b>Rinse out fluff</b> ⇨ See "Rinse out fluff" section.		
<b>Maintenance wash</b>		<b>75 °C</b>
<b>Empty</b>		
<p>With frequent washing at low temperatures there is a danger of a build-up of bacteria in the washer-dryer.</p> <p>Cleaning the washer-dryer will significantly reduce bacteria, mould and biofilm and prevent the build-up of unpleasant odours.</p>		
Note	<ul style="list-style-type: none"> <li>– Optimum results can be achieved by using Miele machine cleaner. Alternatively, a universal powder detergent can be used.</li> <li>– Dispense the machine cleaner or universal detergent directly into the drum.</li> <li>– Do not load any laundry. The drum must be empty for the maintenance wash.</li> </ul>	



## Programme sequence

	Main wash		Rinses		Spinning
	Water level	Wash rhythm	Water level	Rinses	
Cottons		Ⓐ		2-4 <sup>1)2)</sup>	✓
Minimum iron		Ⓑ		2-3 <sup>2)</sup>	✓
Delicates		Ⓒ		2-3 <sup>2)</sup>	✓
Woollens		Ⓔ		2	✓
Shirts		Ⓒ		3	✓
Automatic		Ⓐ Ⓑ		2-3 <sup>2)</sup>	✓
QuickPower		Ⓐ		1	✓
Express		Ⓐ		1	✓
Denim		Ⓑ		2-3 <sup>2)</sup>	✓
Dark garments		Ⓑ		3-4 <sup>2)</sup>	✓
Outerwear		Ⓒ		3	✓
Proofing	-	Ⓑ		1	✓
Sportswear		Ⓒ		2	✓
Trainers <sup>3)</sup>		Ⓓ		2	✓
Silks		Ⓔ		2	✓
Down filled items <sup>4)</sup>		Ⓒ		3	✓
Curtains		Ⓒ		3	✓
Pillows <sup>4)</sup>		Ⓒ		3	✓
Cottons hygiene		Ⓐ		2-3 <sup>2)</sup>	✓
Separate rinse / Starch	-	-		1-2 <sup>5)</sup>	✓

Please see the next page for a description of the symbols.

# WASHING

---

-  = Low water level
-  = Medium water level
-  = High water level
- Ⓐ = Intensive rhythm
- Ⓑ = Normal rhythm
- Ⓒ = Sensitive rhythm
- Ⓓ = Ultra sensitive rhythm
- Ⓔ = Handwash rhythm
- ✓ = Carried out
- = Not carried out

The washer-dryer has fully electronic controls with automatic load recognition. It takes in the right amount of water required for the programme depending on the amount of laundry and its absorbency rate.

The programme sequences shown in the chart are based on the standard programme with a full load. Extra options which can be selected have not been taken into account.

The washer-dryer's display continually shows which stage of the programme has been reached.

## Special features in the programme sequence

### Anti-crease

At the end of the programme the drum continues to turn at intervals for up to 30 minutes to help prevent creasing.

Exception: There is no anti-crease phase in the *Woolens* and *Silks* programmes.

The door can be opened at any time during the anti-crease phase.

- 1) If a temperature of 60 °C or higher is selected, or with  $\langle 40^{\circ}\text{C} \rangle$  and  $\langle 60^{\circ}\text{C} \rangle$  temperatures, 2 rinses are carried out. If a temperature of less than 60 °C is selected, 3 rinses are carried out.
- 2) An additional rinse is carried out if:
  - there is too much foam in the drum
  - a spin speed lower than 700 rpm has been selected
  - 0 rpm (without spin) has been selected.
- 3) Pre-rinse: a pre-rinse is automatically carried out to remove dust.
- 4) Run-up to spin: a run-up to spin is carried out before the wash process begins to deflate the pillows.
- 5) Extra rinse: an extra rinse is carried out when the Water plus option is selected, if an extra rinse has been activated as described in "Settings".



## Cottons and Minimum iron

PowerWash 2.0, the washing technique developed by Miele, is activated in the *Cottons* programme with small and medium-sized loads and in the *Minimum iron* programme

### How it works

Conventional washing techniques wash with more water than the laundry can absorb. This total volume of water needs to be heated.

The PowerWash 2.0 washing technique only uses slightly more water than the laundry can absorb. The water which has not been absorbed by the laundry heats up the drum and the laundry and is sprayed into the laundry over and over again. This reduces the amount of energy used.

### Activation

The washer-dryer calculates the load at the beginning of the wash programme. PowerWash 2.0 is activated if the following conditions are present:

- there is a small to medium-sized laundry load in the *Cottons* programme and in the *Minimum iron* programme.
- the temperature selected does not exceed 60 °C.
- the final spin speed selected must not be lower than 600 rpm.
- CapDosing (⏏, ⏏) has not been selected for the main wash.

With some options (e.g. Pre-wash, Water plus) PowerWash 2.0 is not activated.

## Special features

### – Drenching phase

The washer-dryer will spin a few times at the beginning of the programme. During spinning, the water discharged is sprayed back into the laundry in order to achieve optimum moisture penetration.

The optimum water level is set at the end of the drenching phase. If necessary, the washer-dryer will pump water away or take in a little more fresh water.

### – Noises during the heating phase

Unusual bubbling noises can occur while the laundry and the drum are being heated.

### – Detergent

Dispense the correct amount of detergent (with smaller loads).

# WASHING

## Options

Options are selected and deselected with the *ProgrammeManager*, *Steam smoothing*, *Stains* or *Further options* buttons.

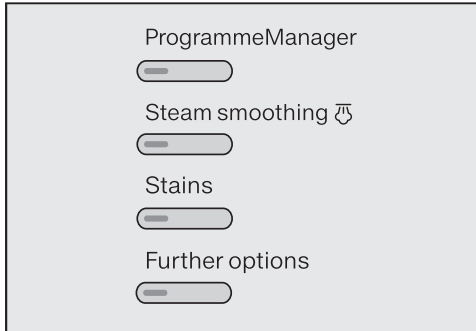

**Example:**

- Press the *ProgrammeManager* button.

The following will appear in the display:



- Touch the  $\nabla$  or  $\nabla$  sensor until the option you want appears in the display.
- Confirm with the *OK* sensor.

The indicator light in the button will come on.

Not all options can be selected with all wash programmes. The "Options - overview" chart for a list of options.

## ProgrammeManager

The ProgrammeManager option can be used to customise the washing programmes to suit your requirements.

### Short

For light soiling without visible stains. The duration of the main wash is reduced.

### Intensive

For hard-wearing laundry that is very heavily soiled. Cleaning efficiency is increased through more intense mechanical action and the application of more heat energy.

### ECO

This option reduces energy consumption whilst maintaining cleaning efficiency. This is achieved by increasing the wash duration and at the same time reducing the wash temperature selected.





### Extra gentle

This option decreases mechanical action in order to reduce creasing.

### Extra quiet





This option reduces noise levels during the programme. Use this if you want to wash during quiet periods (for instance when children are sleeping). The machine will activate the "Rinse hold" option and not spin. The programme duration is longer.

## AllergoWash

This option should be used where high standards of hygiene are required. More energy is used to lengthen temperature holding times and more water is used to increase rinsing efficiency. The items must be suitable for drying in a tumble dryer   and suitable for ironing  .

## Steam smoothing

Steam is injected into the drum at the end of the wash process to reduce creasing. Reducing the maximum load by 50 % will give a better result. For steam smoothing to work properly there needs to be a certain amount of residual moisture still present in the laundry and so the final spin speed is adjusted accordingly.

The garments must be suitable for tumble drying   and suitable for ironing  .

## Stains

In order to clean stained laundry more effectively, you can select a number of types of stain. The wash programme will then adapt to the type of stain selected. You can select one stain per wash cycle.

With some stains, helpful information will also appear in the display when they are selected.

- Confirm the information with *OK*.

## Further options

### Water plus

The water level in the wash and rinse stages is increased.

You can select by how much the water level is increased, see "Settings, Water plus level".

### Pre-wash

For laundry with large amounts of dirt, e.g. dust and sand.

### Soak

For heavily soiled and stained items with protein stains.

A duration of between 30 minutes and 5 hours in 30 minute increments can be chosen for the soak process. See "Settings" for more information.

The factory default setting is 30 minutes.

# WASHING

## Options - overview

	ProgrammeManager						Steam smoothing	Further options		
	Short	Intensive	ECO	Extra gentle	Extra quiet	AllergoWash		Water plus	Pre-wash	Soak
Cottons	✓	✓	✓	✓	✓	✓	✓	✓	✓	✓
Minimum iron	✓	✓	✓	✓	✓	✓	✓	✓	✓	✓
Delicates	✓	✓	✓	✓	✓	✓	✓	✓	✓	✓
Woollens	-	-	-	-	✓	-	-	-	-	-
Shirts	✓	✓	✓	✓	✓	✓	✓ <sup>1)</sup>	✓	✓	✓
Automatic	✓	✓	✓	✓	✓	✓	✓	✓	✓	✓
QuickPower	-	-	-	-	-	-	✓	✓	-	-
Express	✓	-	-	-	✓	-	✓	-	-	-
Denim	✓	✓	✓	✓	✓	✓	✓	✓	✓	✓
Dark garments	✓	✓	✓	✓	✓	✓	✓	✓	✓	✓
Outerwear	✓	✓	✓	✓	✓	✓	-	✓	✓	✓
Proofing	-	-	-	-	✓	-	-	-	-	-
Sportswear	✓	✓	✓	✓	✓	✓	-	✓	✓	✓
Trainers	-	-	-	✓	✓	-	-	✓	✓	-
Silks	-	-	-	-	✓	-	-	-	-	-
Down filled items	-	✓	✓	✓	✓	✓	-	✓	✓	-
Curtains	-	✓	✓	✓	✓	✓	✓	✓	✓	-
Pillows	-	✓	✓	✓	✓	✓	-	✓	✓	-
Cottons hygiene	-	-	-	-	✓	-	✓	✓	✓	✓
Separate rinse / Starch	-	-	-	-	✓	-	-	✓	-	-

✓ can be selected

- cannot be selected

<sup>1)</sup> can be deselected

## Detergent

All detergents produced for automatic washing machines are suitable. Follow the manufacturer's instructions and dosage recommendations on the packaging.

### Dispensing aids

Use dispensing aids, (e.g. balls) if these are supplied with the detergent, particularly when using liquid detergent.

### The right amount to dispense will depend on the following:

- the soiling level of the load
- the quantity of the laundry
- the water hardness level.  
Check with your local water supplier if you do not know the hardness level in your area.

### Definition of the soiling level

- Lightly soiled  
No visible dirt or stains. Possibly slight body odour.
- Normally soiled  
Visibly dirty and/or just a few slight stains.
- Heavily soiled  
Soiling and/or stains clearly visible.

## Water softeners

A water softener can be used to cut down on the use of detergents in areas with water hardness levels II and III. Dispense according to the amount specified on the packaging. First add detergent and then the water softener.

You can then use the recommended amount of detergent for water hardness level I.

### Water hardness levels

Hardness scale	Hardness level in mmol/l	German scale °d
I (soft)	0 – 1.5	0 – 8.4
II (medium)	1.5 – 2.5	8.4 – 14
III (hard)	above 2.5	above 14



### Refill packs of detergent

When purchasing detergent buy refill packs wherever possible. This helps reduce the amount of waste packaging.

# WASHING

## Miele recommended detergents

Miele detergents and care products have been specially designed for Miele washing machines. They are available to order via the Miele Webshop or from Miele.

	Miele UltraPhase 1 / 2	Miele Cap 	Miele Cap 	Miele Cap 
Cottons	✓	-	ⓕ	ⓓ
Minimum iron	✓	-	ⓕ	ⓓ
Delicates	✓	-	ⓕ	-
Woollens	-	ⓓ	-	-
Shirts	✓	-	ⓕ	ⓓ
Automatic	✓	-	ⓕ	ⓓ
QuickPower	✓	-	-	-
Express	✓	-	-	-
Denim	✓	-	ⓕ	-
Dark garments	✓	-	ⓕ	-
Outerwear	-	ⓐ	-	-
Proofing	-	-	ⓖ	-
Sportswear	-	ⓐ	-	-
Trainers	-	ⓐ	-	-
Silks	-	ⓔ	-	-
Down filled items	-	ⓑ	-	-
Curtains	✓	-	-	ⓓ
Pillows	✓	-	-	-
Cottons hygiene	✓	-	ⓕ	ⓓ
Separate rinse / Starch	-/-	-/-	ⓕ/-	-/-

✓ Recommended

- Not recommended

ⓐ Sport

ⓑ Down

ⓒ Outdoor

ⓓ WoolCare

ⓔ SilkCare

ⓕ Fabric conditioner

ⓖ Proofing

ⓓ Booster

## Recommended detergents in accordance with Directive (EU) No. 1015/2010

The recommendations apply to the temperature ranges given in the WASHING Programme chart.

	Universal	Coloureds	Delicates and woollens	Specialist
	detergent			
Cottons	✓	✓	-	-
Minimum iron	-	✓	-	-
Delicates	-	-	✓	-
Woollens	-	-	✓	✓
Shirts	✓	✓	-	-
Automatic	-	✓	-	-
QuickPower	✓	✓	-	-
Express	-	✓ <sup>1)</sup>	-	-
Denim	-	✓ <sup>1)</sup>	-	-
Dark garments	-	✓ <sup>1)</sup>	-	-
Outerwear	-	-	✓	✓
Sportswear	-	-	✓	✓
Trainers	-	✓ <sup>1)</sup>	-	-
Silks	-	-	-	✓
Down filled items	-	-	✓ <sup>1)</sup>	✓
Curtains	✓ <sup>2)</sup>	-	-	-
Pillows	-	-	✓ <sup>1)</sup>	✓
Cottons hygiene	✓ <sup>2)</sup>	-	-	-
Starch	-	-	-	✓

✓ Recommended

- Not recommended

<sup>1)</sup> Liquid detergent

<sup>2)</sup> Powder detergent

# WASHING

## Dispensing fabric conditioner and liquid starch at the end of the programme

### Fabric conditioner

makes garments soft to handle and helps prevent static cling when tumble drying.

### Synthetic starch

provides good stiffness to fabric.

### Natural starch

stiffens and gives body to fabric.

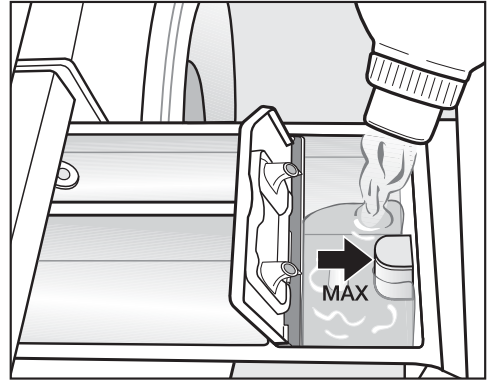

- Add the fabric conditioner or liquid starch to the ☼ compartment or insert the appropriate capsule. **Do not exceed the maximum level mark.**

The agent will be automatically dispensed in the last rinse. At the end of the programme a small amount of water will remain in the ☼ compartment.





If starching frequently, thoroughly clean the dispenser compartment, especially the siphon tube regularly.



## Adding fabric conditioner or liquid starch separately

Prepare the starch in accordance with the manufacturer's instructions on the packaging.

**Tip:** With fabric conditioner the *Water Plus* option has to be selected so that a second rinse can be carried out. An extra rinse has to be activated for *Water plus*. The procedure for doing this is described in the "Settings" section of this manual.

- Add fabric conditioner to the  compartment or insert the appropriate capsule.
- Add liquid starch to the  compartment and powder or viscous starch to the  compartment.
- Select the *Separate rinse / Starch* programme.
- Change the spin speed if necessary.
- If you are using a Cap press the *Cap*  button and activate cap dosing with *OK*.



- Press the *Start/Stop* button.

## Colour run and dye removers/dyes

 Colour run and dye removers are corrosive.

**Do not** use them in this washer-dryer.

Dyes suitable for use in domestic washing machines can be used. However, please note that the salt used in the dyeing process can cause corrosion to stainless steel components in the machine if you dye frequently. Always observe the manufacturer's instructions carefully.

 When using the machine to dye fabric it is essential to select the *Water plus* option.

# DRYING

---

## Separate drying

The separate drying programme should be run if the load in the wash programme is greater than the maximum load permitted for drying, or if you only want to dry part of the load that was washed.

## 1. Prepare the laundry

### Sort the laundry

- Sort the laundry according to type of fibre/weave and the residual moisture content.

This will help you achieve an even drying result.

- Before drying, check the drying symbol on the care label.

If there is no care label, the article should only be tumble dried in a programme specially designed for it.

### Tips on drying

- Do not put soaking wet items into the machine to dry them. Spin them thoroughly for at least 30 seconds after washing.
- Woollens and wool blends tend to become matted and shrink if tumble dried. Only dry these in the *Woollens* programme.
- Pure linen should only be tumble dried if specified as suitable by the manufacturer on the care label, as the surface of the fabric may otherwise become rough.

- Loopknit garments (e.g. T-shirts and underwear) tend to shrink depending on their quality. Do not over-dry these textiles. When purchasing these garments it is advisable to take their shrinkage properties into account.
- Starched laundry can be tumble dried. To achieve the usual finish, double the amount of starch should be used.
- New dark coloured items should not be tumble dried with light coloured items to avoid the risk of them causing discolouration. This also prevents the risk of dark coloured fibres settling on light coloured items and vice versa.
- Observe the maximum load for drying quoted in the "Programme chart". Drying results and creasing are affected by the size of the load. The smaller the load the better the result. Reducing the size of the load will ensure particularly even and crease-free drying.

## 2. Select a programme

Switch the washer-dryer on

- Press the  button.

The interior drum lighting will come on.

The drum lighting will go out automatically after five minutes.

### Select a programme

- with the programme selector dial

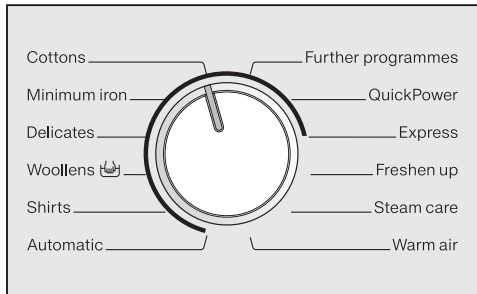

- Turn the programme selector to the required programme.

The maximum load for the programme selected will appear in the display. This will then be replaced by the standard display.

- with the programme selector dial set to the "Further programmes" position

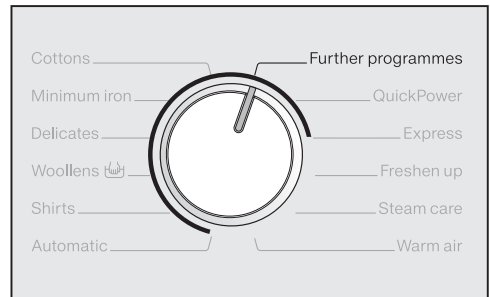

- Turn the programme selector to *Further programmes*.

The following will appear in the display:



- Touch the  $\nabla$  or  $\triangle$  sensor until the programme you want appears in the display.
- Confirm the programme with the OK sensor.

The maximum load for the programme selected will appear in the display. This will then be replaced by the standard display.

# DRYING

---

## Select "Drying".

- Touch the *Washing* and *Drying* sensor until **just** the *Drying* indicator light remains on.

The *Washing* indicator light must **not** be lit up, as this would mean that the relevant washing programme would begin before the drying process.

The maximum (dry) load for the drying programme selected will appear in the display. This will then be replaced by the standard display.

## 3. Load the drum

### Open the door

- Reach under the door grip and pull the door open.

Check the drum for pets or foreign objects before loading it with laundry.

- Load the laundry loosely in the drum.

Overloading places a strain on the textiles and affects drying results. Observe the maximum loads given in the "Programme chart".

### Close the door

- Make sure that no items are caught between the door and the seal.
- Shut the door with a gentle swing.

Detergent dispensing aids, e.g. plastic dispenser balls, can melt during the drying programme and cause damage to the machine and the laundry.

These dispensing aids must be removed from laundry before drying.

The water supply stopcock must be kept open for drying.

## 4. Select programme settings

### Select the drying level

The pre-set drying level for a programme can be changed if required.

- Press the *Drying level* button.

The following will appear in the display:

Normal ✓

- Select the drying level you want with the  $\nabla$  and  $\wedge$  sensors and confirm your selection with the *OK* sensor.

### Select thermospin

The pre-set spin speed for the thermospin can be changed if required.

- Press the *Spin speed* button.

The following will appear in the display:

Spin speed 1600 rpm

- Set the spin speed you want with the  $\nabla$  and  $\wedge$  sensors and confirm your selection with the *OK* sensor.

The thermospin is not carried out if timed drying is selected.

### Select options

You can select extra options to augment drying programmes.

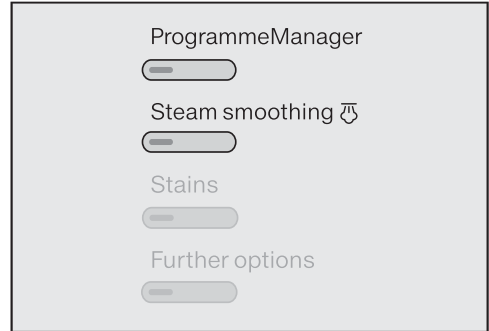

- Select the option you want using the *ProgrammeManager* or *Steam smoothing* button.

The indicator light in the button will light up.

You will not be able to select an option if it is not compatible with the drying programme. See "DRYING", "Options".

### Select delay start

You can use delay start to set the finish time or the start time for a programme.

- Select a delay start time if required.

Please see "Delay start" for more information.

# DRYING

## 5. Start the programme

- Press the flashing *Start/Stop* button.

The door will lock (the  symbol will appear in the display to show this) and the drying programme will start.

The programme status will appear in the display.



The washer-dryer will keep you updated on the programme status and the time remaining for the programme to run.

If a delay start time has been selected, this will count down in the display until the programme starts.

The drum lighting switches off once the programme has started.

## 6. At the end of a programme

The door is still locked during the anti-crease phase and the following will appear alternately in the display:



- Press the *Start/Stop* button.

The door will unlock.

If you have unloaded the drum during the anti-crease phase make sure you spread it out to cool down.

The door unlocks automatically at the end of the anti-crease phase.

- Pull open the door.
- Unload the drum.

Items left in the dryer could be damaged by overdrying when the dryer is next used.  
Check that all items have been removed from the drum.

- Switch the washer-dryer off.

See "After each washing and drying programme" in "WASHING" AND "DRYING"

## Programme chart

<b>Cottons</b>		<b>Max. load 4.0 kg*</b>
<b>Extra dry, Normal+, Normal**</b>		
Use for	Single and multi-layered cotton fabric such as towelling, jerseywear, T-shirts, underwear, workwear, covers, flannelette bed linen and baby clothes.	
Note	Do not use <i>Extra dry</i> for jersey fabric (e.g. T-shirts, underwear), as they have a tendency to shrink. Select <i>Extra dry</i> for multi-layered and very thick fabric.	
<b>Hand iron <math>\Delta</math>, Hand iron <math>\Delta\Delta</math>**<sup>1</sup>, Machine iron, Smoothing<sup>1</sup>, Timed drying<sup>2</sup></b>		
Use for	Cotton or linen fabric requiring further processing, e.g.: table linen, bed linen, starched laundry.	
Note	To prevent laundry from drying out it should be rolled up until you are ready for ironing.	
<b>Minimum iron</b>		<b>Max. load 3.5 kg*</b>
<b>Normal +, Normal**<sup>1</sup>, Hand iron <math>\Delta</math>, Smoothing<sup>1</sup>, Timed drying<sup>2</sup></b>		
Use for	Minimum iron items made of cotton, synthetic or mixed fibre, e.g.: workwear, tunics, tops, dresses, trousers, table linen and socks.	
<b>Delicates</b>		<b>Max. load 1.0 kg*</b>
<b>Normal, Hand iron <math>\Delta</math>, Timed drying<sup>2</sup></b>		
Use for	Delicate items with the  symbol on the care label made of synthetic fibre, mixed fibre, rayon and easy care cotton, e.g. shirts, blouses, lingerie and appliqued garments.	
Note	Reducing the load will reduce creasing.	

\* Weight of dry laundry

\*\* Note for test institutes: Programme setting for testing in accordance with EN 61121

<sup>1,2</sup> See page following the chart

# DRYING





<b>Woollens</b>		<b>Max. load 1.0 kg*</b>
<b>3 minutes</b>		
Use for	Woollen garments and fabric containing wool blends, e.g. pullovers, jackets and socks.	
Note	<ul style="list-style-type: none"> <li>– Wool and wool blend fabrics; woollen garments are only fluffed up, they are not dried completely.</li> <li>– Remove garments as soon as the programme has finished.</li> </ul>	
<b>Shirts</b>		<b>Max. load 1.0 kg*</b>
<b>Normal+, Normal, Hand iron <math>\Delta</math>, Smoothing<sup>1</sup>, Timed drying<sup>2</sup></b>		
Use for	Shirts and blouses.	
Note	<ul style="list-style-type: none"> <li>– Turn shirts and blouses inside out, do up buttons and turn collars and cuffs inwards.</li> <li>– The laundry is dampened before the programme starts to help reduce creasing.</li> </ul>	
<b>Automatic plus</b>		<b>Max. load 3.0 kg*</b>
<b>Normal+, Normal, Hand iron <math>\Delta</math>, Smoothing<sup>1</sup>, Timed drying<sup>2</sup></b>		
Use for	Mixed loads of garments suitable for the <i>Cottons</i> and <i>Minimum iron</i> programmes. Sort according to colour.	
<b>QuickPower</b>		<b>Max. load 4.0 kg*</b>
<b>Extra dry, Normal+, Normal, Hand iron <math>\Delta</math>, Hand iron <math>\Delta\Delta</math>, Machine iron, Smoothing<sup>1</sup>, Timed drying<sup>2</sup></b>		
Use for	Garments suitable for the <i>Cottons</i> programme.	
Note	The programme duration is particularly short when washing and drying <b>normally</b> soiled laundry in a continuous sequence.	

\* Weight of dry laundry

<sup>1,2</sup> See page following the chart



# DRYING

<b>Express</b>		<b>Max. load 3.5 kg*</b>
<b>Extra dry, Normal+, Normal, Hand iron <math>\Delta</math>, Hand iron <math>\Delta\Delta</math>, Machine iron, Smoothing<sup>1</sup>, Timed drying<sup>2</sup></b>		
Use for	Garments suitable for the Cottons programme.	
Note	The programme duration is particularly short when washing and drying <b>lightly</b> soiled laundry in a continuous sequence.	
<b>Freshen up</b>		<b>Max. load 1.0 kg*</b>
<b>Normal, Hand iron <math>\Delta\Delta</math>, Timed drying<sup>2</sup></b>		
Use for	Clean dry garments and garments that have been worn briefly and are not soiled.	
Note	<p>The laundry is dampened before the programme starts to help reduce creasing.</p> <ul style="list-style-type: none"> <li>– <b>Normal:</b> for garments that are required immediately.</li> <li>– <b>Hand iron <math>\Delta\Delta</math>:</b> for garments that are to be ironed or hung out to dry completely on a coat hanger.</li> </ul>	
Note	Creasing <b>increases</b> the larger the load and the longer the drying time.	
<b>Steam care</b>		<b>Max. load 2.0 kg*</b>
<b>Hand iron <math>\Delta</math>, Hand iron <math>\Delta\Delta</math>, Timed drying<sup>2</sup></b>		
Use for	<p>Reducing the amount of creasing in damp, freshly washed and spun cotton or linen garments.</p> <p>The garments must be suitable for drying in a tumble drying   and suitable for ironing  .</p>	
Note	<ul style="list-style-type: none"> <li>– Remove garments as soon as the programme has finished and hang them up on a coat hanger.</li> <li>– Not suitable for garments made of wool or wool blend fabric.</li> </ul>	

\* Weight of dry laundry

<sup>1,2</sup> See page following the chart

# DRYING

<b>Timed drying warm air</b>		<b>Max. load 4.0 kg*</b>
<b>Timed drying<sup>2</sup></b>		
Use for	<ul style="list-style-type: none"> <li>– Multi-layered items whose layers have different drying characteristics, e.g. jackets, pillows, sleeping bags and other voluminous items.</li> <li>– For drying and airing individual items.</li> </ul>	
Note	Do not select the longest drying time to start with. Check the items as you are drying them to find the optimum time.	

## Further programmes

<b>Denim</b>		<b>Max. load 3.0 kg*</b>
<b>Extra dry, Normal+, Normal, Hand iron <math>\Delta</math>, Hand iron <math>\Delta\Delta</math>, Machine iron, Smoothing<sup>1</sup>, Timed drying<sup>2</sup></b>		
Use for	Denim garments, e.g. jeans, jackets, skirts, shirts	
<b>Dark garments</b>		<b>Max. load 3.0 kg*</b>
<b>Normal+, Normal, Hand iron <math>\Delta</math>, Smoothing<sup>1</sup>, Timed drying<sup>2</sup></b>		
Use for	Black and dark items made of cotton or mixed fibres.	
<b>Outerwear</b>		<b>Max. load 2.5 kg*</b>
<b>Normal+, Normal, Hand iron <math>\Delta</math>, Smoothing<sup>1</sup>, Timed drying<sup>2</sup></b>		
Use for	Outerwear which is suitable for drying in a tumble dryer.	
<b>Proofing</b>		<b>Max. load 2.5 kg*</b>
<b>Normal</b>		
Use for	Thermally fixing textiles which are suitable for tumble drying and have been treated with a proofing agent.	
<b>Sportswear</b>		<b>Max. load 2.5 kg*</b>
<b>Normal+, Normal, Hand iron <math>\Delta</math>, Smoothing<sup>1</sup>, Timed drying<sup>2</sup></b>		
Use for	Sportswear which is suitable for drying in a tumble dryer.	

\* Weight of dry laundry

1.2 See page following the chart

# DRYING

<b>Trainers</b>		<b>Max. 2 pairs</b>
<b>Timed drying<sup>2</sup></b>		
Use for	Trainers that are specified as suitable for tumble drying by their manufacturer.	
Note	<ul style="list-style-type: none"> <li>– The drum does not rotate.</li> <li>– Insoles should be removed and placed in the drum with the shoes.</li> </ul>	
<b>Silks</b>		<b>Max. load 1.0 kg*</b>
<b>5 minutes</b>		
Use for	Silk garments which are suitable for tumble drying, e.g. blouses and shirts	
Note	<ul style="list-style-type: none"> <li>– For reduced creasing.</li> <li>– Items are not dried completely in this programme.</li> <li>– Remove garments as soon as the programme has finished.</li> </ul>	
<b>Down filled items</b>		<b>Max. load 2.5 kg*</b>
<b>Timed drying<sup>2</sup></b>		
Use for	Jackets, sleeping bags, pillows and other down-filled items that are suitable for tumble drying.	
Note	Check the items as you are drying them to find the optimum time.	
<b>Pillows</b>		<b>2 pillows (40 x 80 cm) or 1 pillow (80 x 80 cm)</b>
<b>Timed drying<sup>2</sup></b>		
Use for	Pillows with synthetic filling that are suitable for tumble drying	
Note	Pillows can still feel damp after being dried. You can use this programme several times until the pillow feels dry.	

\* Weight of dry laundry

1.2 See page following the chart

# DRYING

Cottons hygiene		Max. load 3.0 kg*
<b>Normal</b>		
Use for	Cottons and linen fabric that are not sensitive to heat and which will be in direct contact with the skin, e.g. underwear, baby clothes, bed linen, towelling.	
Note	The laundry will feel drier because of the longer temperature holding time.	
Cool air		Max. load 4.0 kg*
<b>Timed drying<sup>2</sup></b>		
Use for	Any item which only needs airing.	

\* Weight of dry laundry

- Smoothing:** Garments are dampened before the programme starts to help reduce creasing. Textiles are not completely dried in this programme to make them easier to iron. The drying temperature is determined by the programme being used.
- Timed drying:** Timed drying is particularly suitable for small loads and for drying individual items. Garments are dried in warm air (durations between 15 minutes and 2 hours can be selected). The drying programme is determined by the programme being used. Do not select the longest drying time to start with. Check the items as you are drying them to find the optimum time.

## Options

Options are selected and deselected with the *ProgrammeManager* or *Steam smoothing* buttons.

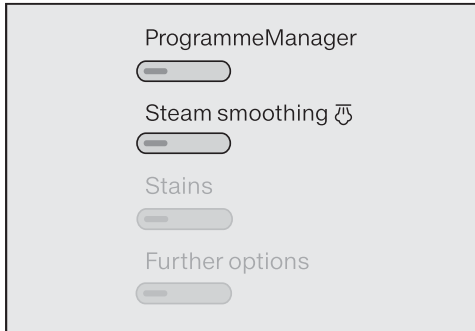

## ProgrammeManager

### Extra gentle

Delicate textiles such as acrylics are dried gently (☺ care label).

In some programmes the thermospin is not carried out when the *Extra gentle* option is selected.

In some programmes the programme duration will increase when *Extra gentle* is selected because of the lower temperature

### Extra quiet

If you want to dry clothes in quiet periods, the noise level of the washer-dryer can be reduced.

- The buzzer is deactivated
- The thermospin is limited to a maximum of 900 rpm.

## Steam smoothing

In order to reduce creasing, the laundry undergoes a smoothing process with steam at the end of the programme. Reducing the maximum load by 50% will give a better result.

The garments must be suitable for tumble drying ☺ ☺ and suitable for ironing ☺ ☺.

## Thermospin

A thermospin is carried out in some drying programmes to reduce energy consumption.

The thermospin is not carried out if timed drying is selected.

The thermospin is not carried in some programmes if the *Extra gentle* option has been selected.

The maximum spin speed for the thermospin is the maximum permitted final spin speed for the appropriate washing programme.

The thermospin can be reduced to 800 rpm.

# DRYING

## Overview of options and the thermospin

None of the options can be selected with programmes which are not listed in the chart below.

	Extra gentle	Extra quiet	Steam smoothing	Thermo spin
Cottons	✓	✓	✓	✓
Minimum iron	✓	✓	✓	✓
Delicates	✓	✓	✓	-
Woollens	-	✓	-	-
Shirts	✓	✓	✓ <sup>1)</sup>	-
Automatic	✓	✓	✓	✓
QuickPower	-	-	✓	✓
Express	-	✓	✓	✓
Freshen up	-	-	✓ <sup>2)</sup>	-
Steam care	-	-	✓ <sup>2)</sup>	-
Denim	✓	✓	✓	✓
Dark garments	✓	✓	✓	✓
Outerwear	✓	✓	-	✓
Proofing	-	✓	-	-
Sportswear	✓	✓	-	✓
Trainers	✓	✓	-	-
Silks	-	✓	-	-
Down filled items	✓	✓	-	-
Pillows	✓	✓	-	-
Cottons hygiene	-	✓	✓	✓

✓ can be selected / - cannot be selected

<sup>1)</sup> can be deselected

<sup>2)</sup> cannot be deselected

## Washing and drying in one continuous sequence

It is advisable to wash and dry in a continuous sequence when the amount of laundry to be washed does not exceed the amount to be dried and the amount to be dried does not exceed the permitted dry weight for the programme.

It is very important to read the sections "Separate washing" and "Separate drying" before proceeding.

### 1. Prepare the laundry

- Empty all pockets.
- Sort the laundry according to colour and type of fibre/weave.
- Check the symbols on the care labels.

### 2. Select a programme

- Switch the washer-dryer on.
- Select the programme you want.
- Touch the sensor for *Washing* and *Drying* repeatedly, until the *Washing* and *Drying* indicators are lit up.

### 3. Load the drum

- Open the door.

Check the drum for pets or foreign objects before loading it with laundry.

- Unfold the laundry and load loosely into the drum.

Detergent dispensing aids, e.g. plastic dispenser balls, can melt during the drying programme and cause damage to the machine and the laundry.

These dispensing aids must be removed from laundry before drying.

- Close the door.

# WASHING AND DRYING

---

## 4. Select programme settings

- Select the degree of soiling level.
- Select the temperature, spin speed and drying level and confirm each with *OK*.

The minimum spin speed is limited to 800 rpm.  
In some programmes it cannot be altered.

To prevent laundry forming a ring against the drum wall, the spin speed is limited to a maximum of 1200 rpm when washing and drying in a continuous sequence.

- Select further options if required.

The spin speed for washing is used for the thermospin.  
The spin speed is limited to a maximum of 900 rpm if *Extra quiet* has been selected.

The thermospin is not carried out if timed drying is selected.

- Select a delay start time if required.

## 5. Add detergent

- Dispense detergent either with Cap dosing or via the detergent dispenser drawer.

## 6. Programme start/finish

- Press the *Start/Stop* button.

The door will lock and the programme status will appear in the display.

The anti-crease phase will start at the end of the programme.

The door remains locked during the anti-crease phase.

- Press the *Start/Stop* button.

The door will unlock.

If you have unloaded the drum during the anti-crease phase make sure you spread it out to cool down.

The door unlocks automatically at the end of the anti-crease phase.

- Pull the door open and unload the drum.

See "After each washing or drying programme".



## After each washing or drying programme

- Open the drum door **fully**.

 **Caution!** The metal cap is hot after drying.

Do not touch the metal cap located on the inside of the door glass.

- Unload the drum.

Laundry left in the drum could shrink, discolour or suffer damage in the next washing or drying programme. Check that all items have been removed from the drum.

- Check the door seal for foreign objects. Remove fluff from the seal and from the door glass after drying.

**Tip:** Leave the door slightly open to allow the drum to dry.

- Switch the washer-dryer off with the  button.

**Tip:** Leave the detergent dispenser drawer slightly open to allow it to dry.

## "Rinse out fluff" programme

During drying fluff can collect in the drum and also in the suds container. Run the Rinse out fluff programme before the machine is used again so that fluff cannot be deposited on the next load or cause a blockage.

The Rinse out fluff programme must not be used for rinsing laundry. Make sure there are no pieces of laundry in the drum before starting the programme.

- Switch the washer-dryer on.
- With the programme selector dial set to the *Further programmes* position, select the *Rinse out fluff* programme.

Do not use detergent.

- Press the *Start/Stop* button.

Any fluff will be rinsed away within a few minutes.

- If necessary wipe any remaining fluff off the door seal and porthole glass.
- Switch the washer-dryer off.

## Changing the programme sequence

---

### Cancelling a programme

You can cancel a programme at any time after it has started.

- Press the *Start/Stop* button.

The following will appear in the display:



Cancel programme

- Touch the *OK* sensor.

– During washing:

The suds will be pumped away and the programme is cancelled.

– During drying:

The laundry will be cooled down before the door can be opened.

#### If you want to remove the laundry:

- Pull the door open and unload the drum.

#### If you want to select a different programme:

- Close the door.
- Select the programme you want.
- Add detergent to the detergent dispenser drawer, if necessary.
- Press the *Start/Stop* button.

The programme will start.

### Interrupting a programme

- Switch the washer-dryer off with the ⏻ button.
- To continue the programme switch the washer-dryer back on with the ⏻ button.

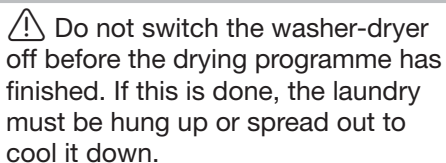

⚠ Do not switch the washer-dryer off before the drying programme has finished. If this is done, the laundry must be hung up or spread out to cool it down.

### To change the programme

You cannot change to a different programme after the current one has started. You will need to cancel the current programme before you can select a new one.

### To alter the temperature

The temperature of a wash programme can be changed within the first 5 minutes of the programme starting, except in the *Cottons* programme.

- Press the *Temperature* button.
- Change the temperature using the ∨ and ∧ sensors and confirm your choice with *OK*.

# Changing the programme sequence

## Altering the spin speed

The final spin speed for a wash programme can be altered up until the spin starts.

- Press the *Spin speed* button.
- Change the spin speed using the ∨ and ∧ sensors and confirm your choice with *OK*.

## Changing drying levels / durations

Drying levels and durations can be changed during the washing process. They cannot be changed once the drying process has started.

- Press the *Drying level* button.
- Change the drying level / time with the ∨ and ∧ sensors and confirm your choice with *OK*.

## Selecting or deselecting drying

The *Drying* function can be selected or deselected whilst a washing programme programme is running if it permitted for that programme.

- Touch the *Drying* sensor.

## Changing options

Some options can be selected and deselected after a programme has started.

If the safety lock has been activated the programme sequence cannot be changed.

## Safety lock

The safety lock prevents the machine being opened or a programme being cancelled or changed during a washing or drying programme.

### To activate the safety lock

- After the programme has started, press the *Start/Stop* button.
- Select *Safety lock on* and confirm your choice with *OK*.

The machine will not accept any changes and will run the selected programme through to the end.

The electronic safety lock is automatically released at the end of the programme.

### To deactivate the safety lock

- Press the *Start/Stop* button.
- Select *Safety lock off* and confirm your choice with *OK*.

## Changing the programme sequence

---

### Adding or removing laundry

You can add or remove items during the first few minutes after the programme has started.

- Press the *Start/Stop* button.

The following will appear in the display:



- Scroll up the list with the  $\nabla$  or  $\wedge$  sensor to:



- Touch the *OK* sensor.

If this message does not appear in the display then it is no longer possible to add items of laundry.

The programme will stop and the door will unlock.

- Pull open the door.
- Add or remove items.
- Close the door.
- Press the *Start/Stop* button.

The programme will continue.

#### Please note:

Once a programme has started successfully the washer-dryer cannot recognise any adjustment to the load.

For this reason, if laundry is added or removed after the start of a programme, the machine will always complete the programme cycle assuming a full load.

With delay start you can choose when you want the programme to start. You can delay the start of the programme from 15 minutes up to a maximum of 24 hours.

## Select delay start

- Touch the *Delay start* sensor.

The following will appear in the display:

A digital display showing the text "Start in" followed by a grey rectangular box containing "00:00 h". The "00" is highlighted with a white border.

- Use the  $\nabla$  and  $\wedge$  sensors to enter the hour and confirm your entry with the *OK* sensor.

The display will change:

A digital display showing the text "Start in" followed by a grey rectangular box containing "03:00 h". The "00" is highlighted with a white border.

- Use the  $\nabla$  and  $\wedge$  sensors to enter the minutes and confirm your entry with the *OK* sensor.

## To begin delay start

- Touch the *Start/Stop* sensor to begin delay start and start the programme.

The following will appear in the display:

A digital display showing a lock icon, the text "Start in", a grey rectangular box containing "3:00 h", and the letter "h".

## To alter Delay start

You can change delay start at any time.

- Touch the *Delay start* sensor.

A grey rectangular button with the text "Change the time" and a white up/down arrow icon on the right side.

- Touch the *OK* sensor.
- Set the time you require.

## Start the programme immediately

- Touch the *Delay start* sensor.
- Touch the  $\nabla$  sensor.

A grey rectangular button with the text "Start now" and a white up/down arrow icon on the right side.

- Touch the *OK* sensor and the programme will start immediately.

## To cancel delay start





- Press the *Start/Stop* button.

A grey rectangular button with the text "Cancel delay start" and a white up/down arrow icon on the right side.









- Touch the *OK* sensor.



Delay start has been cancelled and the door is unlocked.



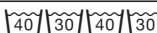

# Garment care label symbols





Washing	
The figure quoted in the bucket is the maximum temperature the garment can be washed at. The number of bars under the symbol indicates the level of agitation permitted.	
	No bar under the symbol: = normal agitation
	One bar under the symbol: = reduced agitation
	Two bars under the symbol: = much reduced agitation
	Hand wash (if no temperature is specified, use the lowest temperature or cold)
	Do not wash



## Programme selection examples

Programme	Garment care label symbols
Cottons	
Minimum iron	
Delicates	
Woollens 	
Silks 	
Express	
Automatic	

Drying	
The number of dots indicates the drying temperature	
	Normal temperature
	Low temperature
	Do not tumble dry

Ironing	
The number of dots indicates the ironing temperature	
	Hot iron (max. sole plate temp. approx. 200 °C)
	Medium hot iron (max. sole plate temp. approx. 150 °C)
	Cool iron (max. sole plate temp. approx. 110 °C). Do not steam iron garments carrying this symbol as this could cause irreversible damage.
	Do not iron

Professional cleaning	
	Dry clean only. The letters indicate the type of cleaning agent required.
	
	Professional Wet Clean only
	Do not dry clean

Bleaching	
	Any oxidising bleaching agent can be used
	Only use an oxygen based bleach or a non-chlorine bleach
	Do not bleach

⚠ Disconnect the machine from the mains electricity supply before cleaning or maintenance.

⚠ Do not use solvents, abrasive cleaners, glass cleaners or all-purpose cleaners.

⚠ The washer-dryer must not be hosed down.

### External casing and fascia panel

- Clean the washer-dryer with a mild cleaning agent or a solution of washing-up liquid and water. Dry with a soft cloth.
- The drum can be cleaned with a proprietary stainless steel cleaning agent, following the manufacturer's instructions on the packaging.

### Cleaning the porthole glass

- Clean the inside of the porthole glass from time to time and the metal cap inside the porthole glass with a suitable mild cleaning agent or with soapy water.
- Dry both with a soft cloth.

### Cleaning the detergent dispenser drawer

Washing at low temperatures and the use of liquid detergent can lead to a build-up of mould and bacteria in the detergent dispenser drawer.

- For hygiene reasons, clean the entire drawer at regular intervals.

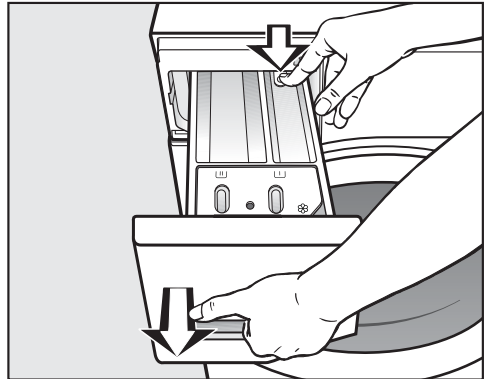

- Pull out the detergent dispenser drawer until a resistance is felt. Press down the release button and at the same time pull the drawer right out of the machine.
- Clean the drawer with hot water.

# Cleaning and care

## Cleaning the siphon tube and the channel

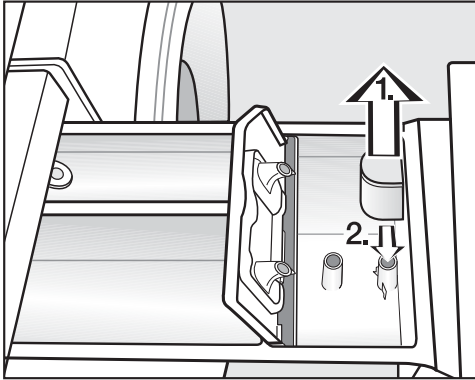

- Clean the siphon.

1. Remove the siphon from the ☒ compartment and rinse under hot running water. Clean the siphon tube at the same time.

2. Replace the siphon.

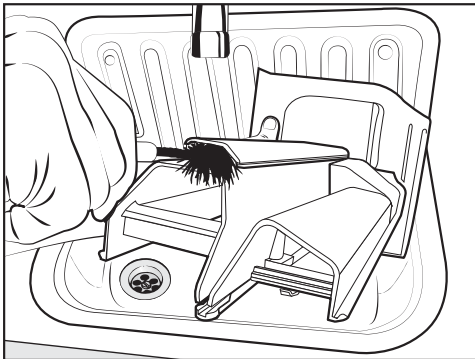

- Clean the fabric conditioner channel with a brush and hot water.

Liquid starch results in clogging. Frequent use of liquid starch can cause the siphon to become clogged.

## Cleaning the detergent dispenser drawer housing

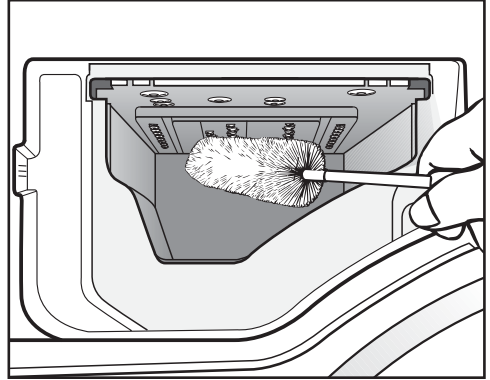

- Use a bottle brush to remove detergent residues and limescale from the jets inside the detergent dispenser drawer housing.

- Replace the detergent dispenser drawer.

**Tip:** Leave the detergent dispenser drawer slightly open to allow it to dry.

## Cleaning the drum

Washing at low temperatures and/or using liquid detergent can cause bacteria and unpleasant odours to build up in the washer-dryer. Use the Maintenance wash programme to clean the machine. Run this programme regularly or at the latest when Hygiene info appears the display.



### Cleaning the water inlet filter

This washer-dryer has a filter to protect the water inlet valve. The filter in the union in the open end of the inlet hose should be replaced every 6 months or so, or more often if there are frequent interruptions to the water supply.

- First turn off the stopcock.
- Unscrew the inlet hose from the stopcock.

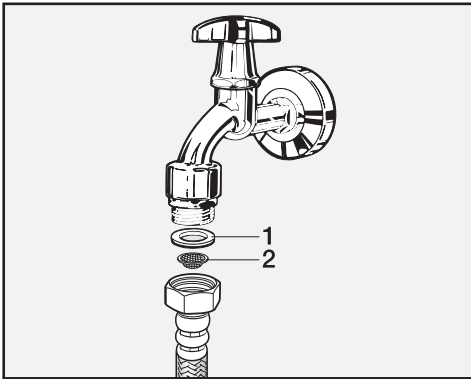

- Remove the rubber seal **1** from the recess.
- Hold the free end of the inlet hose downwards. Plastic filter **2** will drop out.
- Clean the plastic filter.

- Put the filter and seal back in the reverse order and reconnect the hose.
- Turn on the stopcock and check the connection is watertight. If water drips out, tighten the connection.

The filter **must** be put back in place after cleaning.

# What to do if ...

## Problem solving guide

With the help of the following guide, minor faults in the performance of the machine, some of which may result from incorrect operation, can be put right without contacting Miele Service. This will save time and money.



The following guide may help you to find the reason for a fault, and to correct it. You should, however, note the following:

 Repairs and other work by unqualified persons can cause considerable danger to users.









Repair work to electrical appliances should only be carried out by a suitably qualified person in strict accordance with current local and national safety regulations.

Some of the messages in the display are more than one line long. Touch the  $\vee$  or  $\wedge$  sensor to read them in full.

## A programme does not start

Problem	Cause and remedy
<b>The display remains dark, and the Start/Stop button indicator light does not come on.</b>	There is no power to the machine. <ul style="list-style-type: none"><li>■ Check whether the mains plug is plugged in and switched on.</li><li>■ Check whether the fuse or circuit breaker has tripped.</li></ul>
	The washer-dryer has switched off automatically to save energy. <ul style="list-style-type: none"><li>■ Switch the washer-dryer back on by using the  button.</li></ul>
<b>The display prompts you to enter a code.</b>	Access via a code has been activated. <ul style="list-style-type: none"><li>■ Enter the code and confirm the entry. Deactivate the code if you do not wish this message to appear in the display the next time the machine is switched on.</li></ul>
<b>The following appears in the display:</b>   Service Door release	The door is not closed properly. The door lock could not engage. <ul style="list-style-type: none"><li>■ Close the door again.</li><li>■ Start the programme again.</li></ul> If the fault message appears again, contact the Service Department.

### The following fault messages appear in the display and the programme stops

Problem	Cause and remedy
 Water intake See 	<p>The water inlet is blocked or restricted.</p> <ul style="list-style-type: none"> <li>■ Check whether the stopcock is opened properly.</li> <li>■ Check whether the inlet hose is kinked.</li> <li>■ Check whether the water pressure is too low.</li> </ul> <p>The filter in the water inlet is blocked.</p> <ul style="list-style-type: none"> <li>■ Clean the filter.</li> </ul>
 Drainage See 	<p>The water outlet is blocked or restricted. The drain hose has been fixed too high.</p> <ul style="list-style-type: none"> <li>■ Clean the drain filter and the drain pump.</li> <li>■ The maximum delivery head is 1 m.</li> </ul>
  Service Water-proof	<p>The water protection system has reacted.</p> <ul style="list-style-type: none"> <li>■ Close the stopcock.</li> <li>■ Call Service.</li> </ul>
  Service Fault F	<p>There is a fault.</p> <ul style="list-style-type: none"> <li>■ Start the programme again. If the fault message appears again, contact the Service Department.</li> </ul>

To switch off the fault messages: switch the washer-dryer off with the  button.

# What to do if ...

## A message appears in the display at the end of the programme

Message	Cause and remedy
<b>i</b> Check filter + jet	<p>The pumps are dirty.</p> <ul style="list-style-type: none"><li>■ Clean the pumps as described in "Problem solving guide - Opening the door in the event of a blocked drain outlet and/or power failure".</li><li>■ Start the programme again after cleaning the pumps.</li></ul> <p>The jet in the top of the door ring is blocked with fluff.</p> <ul style="list-style-type: none"><li>■ Remove the fluff with your finger. Do not use any sharp or pointed tools to do this.</li><li>■ Start the programme again after cleaning the jet.</li></ul> <p>If the fault message appears again, contact the Service Department. The washer-dryer can still be used but with reduced functionality.</p>
<b>i</b> Align the machine	<p>The smoothing process which the laundry undergoes at the end of the programme could not be carried out properly.</p> <ul style="list-style-type: none"><li>■ Check that the washer-dryer is aligned correctly as described in "Installation and connection - Leveling the machine".</li><li>■ Check whether the maximum delivery height of 1.0 m has been exceeded.</li></ul> <p>If the fault message appears again, contact the Service Department. The washer-dryer can still be used but with reduced functionality.</p>

The messages will appear at the end of the programme and when the washer-dryer is switched on and need to be confirmed with the *OK* sensor.



### A message appears in the display at the end of the programme

Message	Cause and remedy
<b>i</b> Hygiene info	<p>A programme using a temperature above 60 °C has not been run for a long time.</p> <ul style="list-style-type: none"> <li>■ In order to prevent bacteria and unpleasant odours building up in the washer-dryer, run the <i>Maintenance wash</i> programme using Miele machine cleaner or powder detergent.</li> </ul>
<b>i</b> Check dosage	<p>Excessive foam has built up during washing.</p> <ul style="list-style-type: none"> <li>■ Use less detergent next time, and follow the manufacturer's recommended dosage amounts on the packaging.</li> </ul>
<b>i</b> Check load	<p>There is no laundry in the drum.</p> <p>The load is too small. The laundry is still damp because the residual moisture content in the laundry could not be measured.</p> <ul style="list-style-type: none"> <li>■ In future use a <i>Timed drying</i> programme for small amounts of laundry.</li> </ul> <p>The amount of laundry exceeded the max. load for the selected programme.</p> <ul style="list-style-type: none"> <li>■ Observe the maximum loads given in the Programme chart.</li> </ul>



The messages will appear at the end of the programme and when the washer-dryer is switched on and need to be confirmed with the *OK* sensor.

# What to do if ...

## General problems with the washer-dryer

Problem	Cause and remedy
<b>The washer-dryer is not steady during a spin cycle.</b>	The machine feet are not level. <ul style="list-style-type: none"> <li>■ Level the washer-dryer and secure the feet.</li> </ul>
<b>Unusual pumping noises.</b>	This is not a fault. These slurping noises occur at the end of the pump sequence as a normal part of operation.
<b>Spinning sounds during the drying process.</b>	This is not a fault. The machine will spin, even during a drying programme (thermospin).
<b>Large amounts of detergent residue remain in the detergent dispenser drawer.</b>	The water pressure is too low. <ul style="list-style-type: none"> <li>■ Clean the filters in the water inlet.</li> <li>■ Select <i>Water plus</i>.</li> </ul>
	Powder detergent used in conjunction with water softeners tends to become sticky. <ul style="list-style-type: none"> <li>■ In future, add washing powder into the dispenser drawer first, and then add the water softener.</li> </ul>
<b>Fabric conditioner is not completely dispensed or too much water remains in the  compartment.</b>	The siphon tube is not correctly positioned or is clogged. <ul style="list-style-type: none"> <li>■ Clean the siphon, see "Cleaning and care - Cleaning the detergent dispenser drawer".</li> </ul>
<b>The display is in a different language.</b>	A different language has been selected in "Settings" "Language  ". <ul style="list-style-type: none"> <li>■ Set the language you want.</li> </ul>
	The flag symbol serves as a guide.
<b>Foam comes out of the detergent dispenser drawer while the <i>Rinse out fluff</i> programme is running.</b>	Residual detergent from the last programme is still present in the suds container. <ul style="list-style-type: none"> <li>■ Make sure you dispense the correct amount of detergent.</li> <li>■ Follow the dispensing recommendations on the packaging.</li> </ul>

## General problems with the washer-dryer

Problem	Cause and remedy
<p><b>At the end of the programme there is still liquid in the capsule.</b></p>	<p>The small pipe in the detergent dispenser drawer onto which the capsule is placed is blocked.</p> <ul style="list-style-type: none"> <li>■ Clean the small pipe.</li> </ul>
	<p>This is not a fault. For technical reasons a small amount of water will remain in the capsule.</p>
<p><b>There is water next to the capsule in the fabric conditioner compartment.</b></p>	<p>The Cap  sensor was not activated or an empty capsule was not removed at the end of the last programme.</p> <ul style="list-style-type: none"> <li>■ Make sure that you remember to activate the Cap  sensor the next time you insert a capsule.</li> <li>■ Remove and then dispose of the empty capsule at the end of each programme.</li> </ul>
	<p>The small pipe in the detergent dispenser drawer onto which the capsule is placed is blocked.</p> <ul style="list-style-type: none"> <li>■ Clean the small pipe.</li> </ul>
<p><b>The laundry has not been spun properly and the laundry is still wet.</b></p>	<p>The machine detected an imbalance during the final spin cycle and reduced the spin speed automatically.</p> <ul style="list-style-type: none"> <li>■ Include both large and small items in the load as this will give better distribution during spinning.</li> </ul>
<p><b>The display is dark.</b></p>	<p>The display has switched off automatically to save energy (Standby mode).</p> <ul style="list-style-type: none"> <li>■ Press a button. Standby comes to an end.</li> </ul>
<p><b>The time left duration in the display fluctuates.</b></p>	<p>The countdown time adapts constantly to the current washing and drying process.</p>

# What to do if ...

## An unsatisfactory wash result

Problem	Cause and remedy
<b>White residues which look like powder detergent are seen on dark textiles after washing.</b>	<p>The detergent contained compounds (zeolites) to aid water softening which are not soluble in water. These have ended up on the laundry.</p> <ul style="list-style-type: none"><li>■ Try and brush off the residues with a soft brush once the laundry is dry.</li><li>■ Wash dark textiles using a detergent which contains no zeolites. Liquid detergents usually contain no zeolites.</li><li>■ Use the <i>Dark garments</i> programme.</li></ul>
<b>Grey, greasy particles cling to washed laundry.</b>	<p>Insufficient amounts of detergent were used to break down the particles of grease in heavily soiled laundry.</p> <ul style="list-style-type: none"><li>■ Use more detergent.</li><li>■ Before washing the next load, run the <i>Maintenance wash</i> using Miele machine cleaner or a powder detergent.</li></ul>
<b>Liquid detergent does not give the required result.</b>	<p>Liquid detergents usually contain no bleaching agents. They do not remove fruit, coffee and tea stains.</p> <ul style="list-style-type: none"><li>■ Use a general purpose powder detergent containing a bleaching agent.</li><li>■ Pour stain remover into compartment  and liquid detergent into a dispensing ball (<b>remove the dispensing ball before drying!</b>).</li><li>■ Never put stain removers and liquid detergent together in the dispenser drawer.</li></ul>



## Unsatisfactory drying results

Problem	Cause and remedy
<p><b>The laundry is too damp after drying and appears in the display.</b> Check load</p>	<p>The load is too small for the electronics to correctly calculate the residual moisture content.</p> <ul style="list-style-type: none"> <li>■ Start the programme again and instead of a drying level select a <i>Timed drying</i> programme.</li> <li>■ In future use a <i>Timed drying</i> programme for small amounts of laundry.</li> </ul> <p>During spinning, the laundry formed a ring in the drum because the laundry was distributed unevenly. The laundry formed a ring during the thermospin because it was too damp or because the spin speed was set too high.</p> <ul style="list-style-type: none"> <li>■ Open the door and loosen the laundry.</li> <li>■ Start the drying programme again with a lower spin speed, or select <i>Timed drying</i> instead of a drying level.</li> </ul>
<p><b>The laundry feels damp after drying.</b></p>	<p>The <i>Steam smoothing</i> option has been selected.</p> <ul style="list-style-type: none"> <li>■ Unload the laundry and place it on hangers to finish drying.</li> </ul> <p>Warm laundry can feel damp.</p> <ul style="list-style-type: none"> <li>■ Spread the laundry out to cool it down.</li> </ul>
<p><b>The laundry is too damp or too dry after a drying cycle.</b></p>	<p>The desired residual moisture level is between two drying stages.</p> <ul style="list-style-type: none"> <li>■ Change the level of drying as described in "Settings", "Drying levels".</li> </ul>
<p><b>There is still water in the drum after drying.</b></p>	<p>There is a blockage in the water outlet.</p> <ul style="list-style-type: none"> <li>■ Clean the drain filters and the drain pumps as described in "Opening the door in the event of a blocked drain outlet and/or power failure" and check the height of the drainage point.</li> </ul>

## What to do if ...

### The door will not open

Problem	Cause and remedy
<b>The door will not open during a programme.</b>	The door is locked during a programme. <ul style="list-style-type: none"><li>■ Press the Start/Stop button.</li><li>■ Select Cancel programme or Add laundry with the ∨ or ∧ sensors.</li></ul> The door will unlock and you will be able to pull it open.
	There is still water in the drum and the washer-dryer is unable to drain. <ul style="list-style-type: none"><li>■ Clean the drain filters and the drain pumps as described in "Opening the door in the event of a blocked drain outlet and/or power failure".</li></ul>
	The water level in the drum is too high. <ul style="list-style-type: none"><li>■ Cancel the programme. The water will be pumped away.</li></ul>
<b>At the end of the programme or after a programme cancellation:</b> Cooling down or Comfort cooling appears in the display.	For safety reasons the door cannot be opened if the temperature in the drum exceeds 55 °C during washing or 70 °C during drying. <ul style="list-style-type: none"><li>■ Wait until the temperature in the drum has decreased and the message has gone out in the display.</li></ul>
<b>The following appears in the display:</b>  Service Door release	The door lock has jammed. <ul style="list-style-type: none"><li>■ Call Service.</li></ul>

## Opening the door in the event of a blocked drain outlet and/or power cut

- Switch the washer-dryer off.

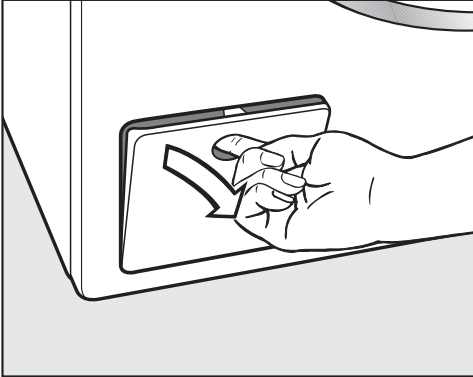

- Open the drain pump access panel.

## Blocked drain outlet

If the drain outlet is blocked, a large quantity of water can remain in the washer-dryer.

**!** If laundry has been washed at a high temperature, water draining out of the machine will still be hot. Danger of scalding!  
Take care when draining the machine.

## Procedure for draining the machine

When draining water from the machine, do not unscrew the drain filters completely or take them right out.

- Place a suitable container, e.g. a Miele universal oven tray under the access panel.

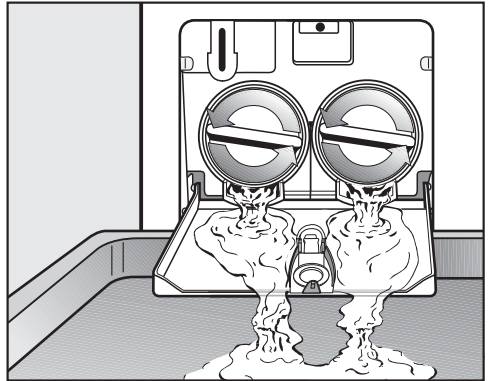

- Slowly and carefully unscrew the filters to let the water out.
- Tighten the drain filters back up again if you need to interrupt the flow of water.

Once the flow of water ceases:

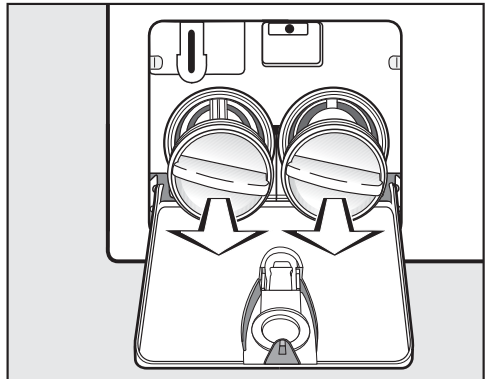

- Remove the drain filters completely.

## What to do if ...

### Clean the drain filters.

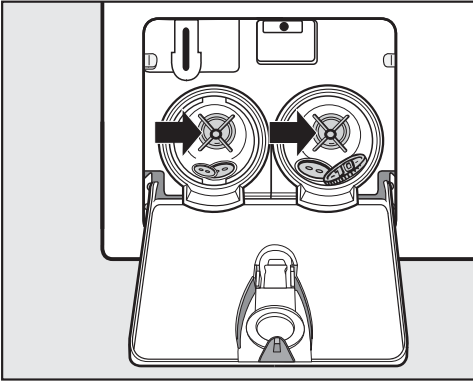

- Clean them thoroughly.
- Remove any foreign objects (e.g. buttons, coins, etc.) and fluff from the filter housing. Turn the impellers by hand to check that they rotate freely.

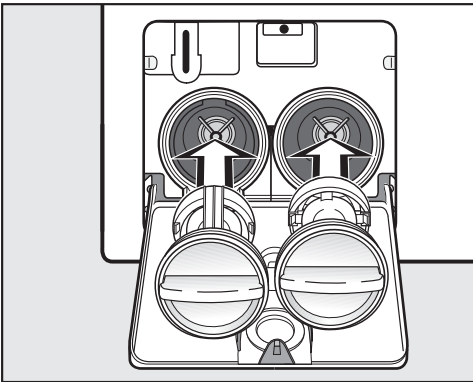

- Replace the drain filters correctly (on the right and left) and tighten them securely.

**!** Overflowing water can cause damage.

Put the drain filter back in place and secure it.

### Open the door

**!** Reaching into a moving drum is extremely dangerous. Danger of injury.

Always make sure that the drum is stationary before reaching in to remove laundry.

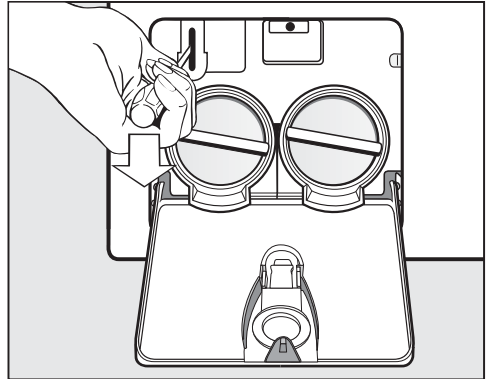

- Use a screwdriver to unlock the door.
- Pull open the door.

## Repairs

In the event of any faults which you cannot remedy yourself, please contact:

- your Miele Dealer, or
- the Miele Service Department.

Contact details for Miele are given at the end of this booklet. N.B. A call-out fee will be charged for service visits where the problem could have been resolved as described in these instructions.

When contacting your Dealer or Miele, please quote the model and serial number of your machine, both of which are shown on the data plate visible above the porthole glass when the door is open.

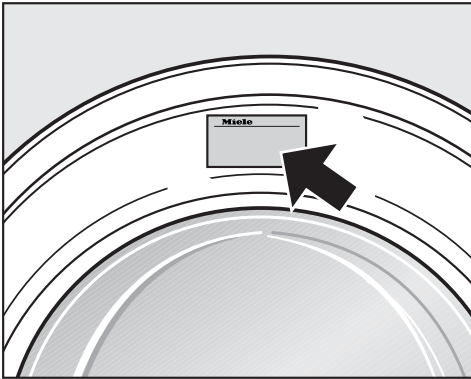

## Guarantee: U.K.

The washer-dryer is guaranteed for a period of 2 years from date of purchase.

In the U.K. you must activate your cover by calling 0330 160 6640 or registering online at [www.miele.co.uk](http://www.miele.co.uk).

## Guarantee: Other countries

For information on the appliance guarantee specific to your country please contact Miele. See end of this booklet for contact details.

## Optional accessories

Optional accessories for this washer-dryer are available from Miele or your Miele dealer.

# Installation and connection

## Front view

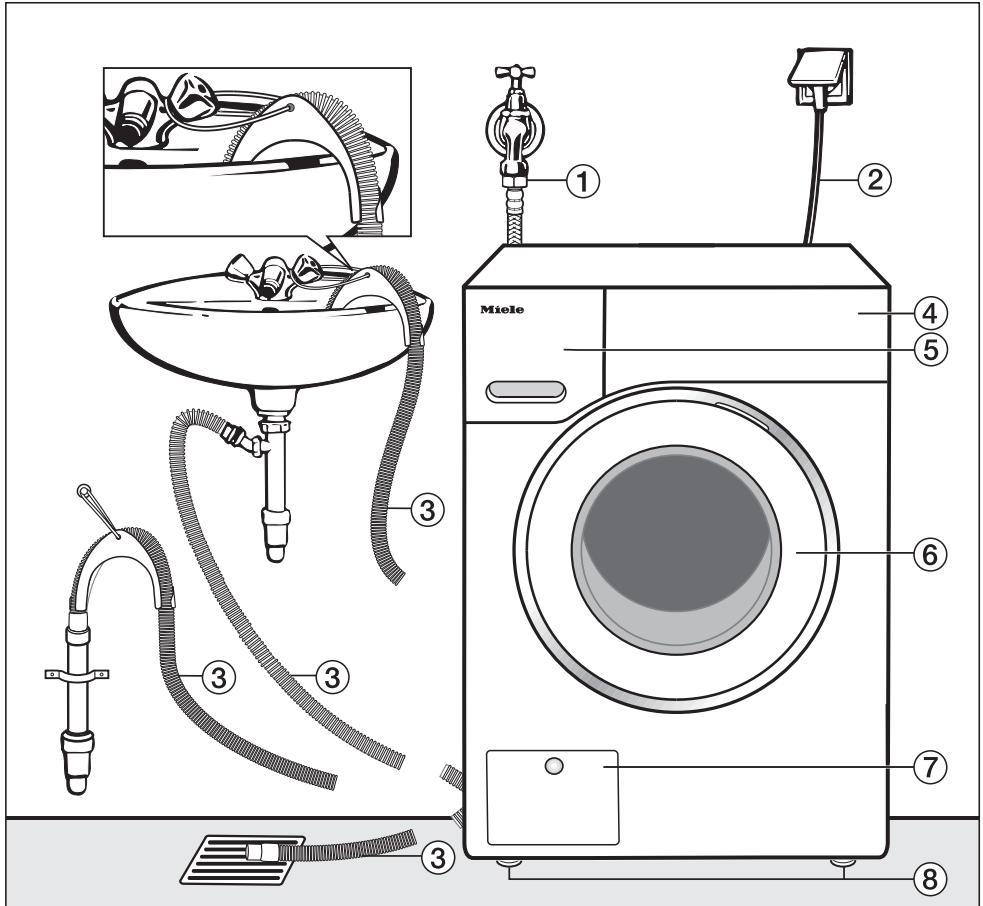

- ① Waterproof-Metal inlet hose (braided)
- ② Electrical connection
- ③ Flexible drain hose (with detachable elbow)
- ④ Control panel
- ⑤ Detergent dispenser drawer
- ⑥ Door
- ⑦ Access to drain filter, drain pump and emergency release
- ⑧ Four height adjustable feet

## Rear view

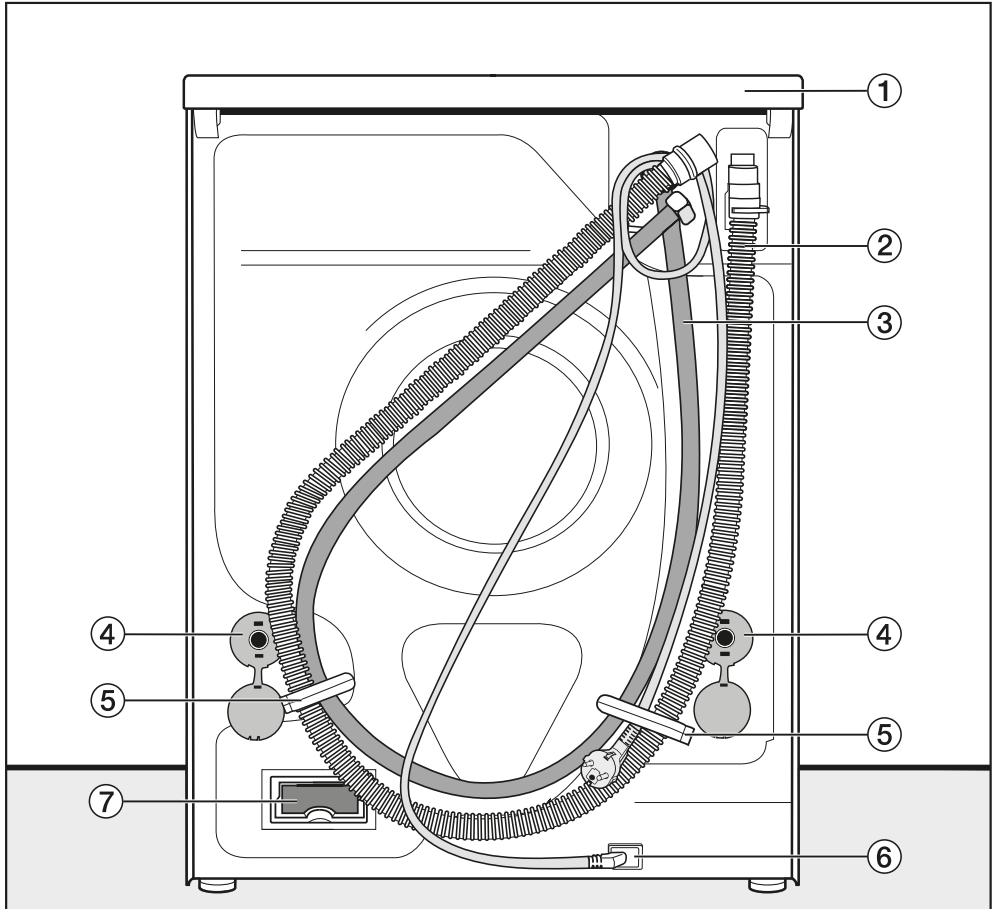

- ① Protruding lid for holding when moving the machine
- ② Drain hose
- ③ Waterproof-Metal inlet hose (braided)
- ④ Safety caps for transit bars
- ⑤ Transport clips for inlet and drain hoses
- ⑥ Electrical connection
- ⑦ Miele@home communication module slot

# Installation and connection

## Installation surface

A concrete floor is the most suitable installation surface for this machine, being far less prone to vibration during the spin cycle than wooden floorboards or a carpeted surface.

Please note:

- The washer-dryer must be level and securely positioned.
- To avoid vibrations during spinning the washer-dryer must not be installed on soft floor coverings.

If installing on a wooden joist floor:

- We recommend installing the machine on a plywood base at least 59 x 52 x 3 cm). The base should span several joists and be bolted to the joist and not only the floorboards. Check for the presence of pipes and cables first.

**Tip:** If possible, install the machine in a corner, as this is usually the most stable part of the floor.

⚠ If the washer-dryer is installed on an existing on-site plinth (concrete or brick), there is a danger of the machine falling off the plinth during the spin cycle.

The washer-dryer **must** be secured with an MTS floor mounting kit (available from Miele).

## Installing the washer-dryer

Hold the washer-dryer by the front feet and by the edge of the lid where it protrudes to the rear of the machine.

⚠ Danger of slippage during spinning.

The machine feet and installation surface must be dry.

## Remove the transit bars

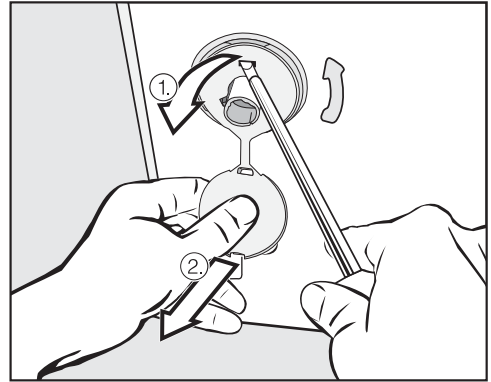

- Remove the left and right covers.

1. Pull on the attached stopper and
2. then use a screwdriver to release the catches at the top and bottom.



## Installation and connection

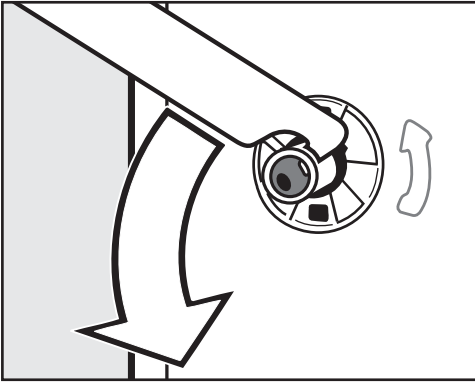

- Using the spanner supplied, turn the left-hand transit bar 90°, then

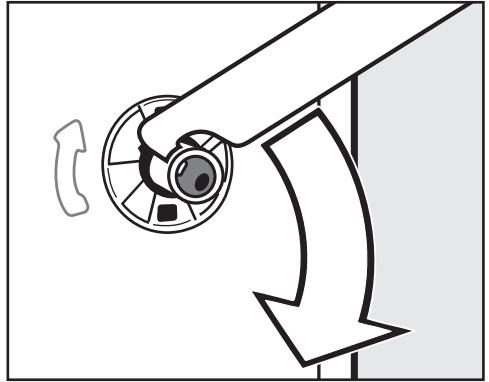

- Turn the right-hand transit bar 90°, then

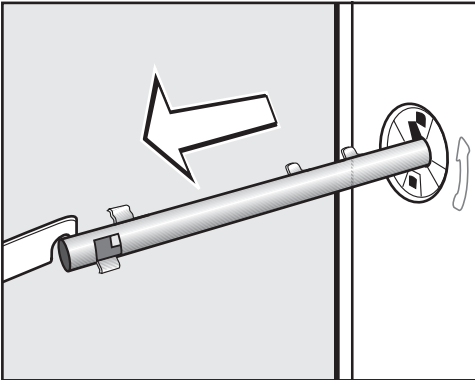

- pull the transit bar out.

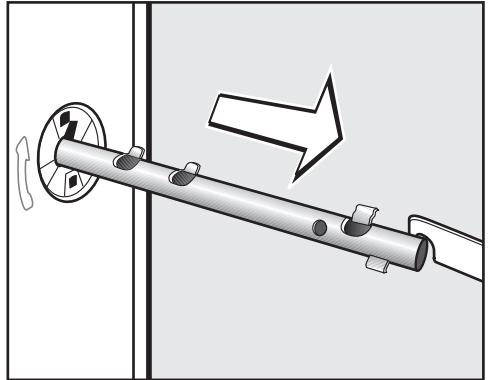

- pull the transit bar out.

## Installation and connection

**!** If the holes are not covered, there is a risk of injury.  
To avoid the risk of injury the holes for the transit bars must be covered after they have been removed.

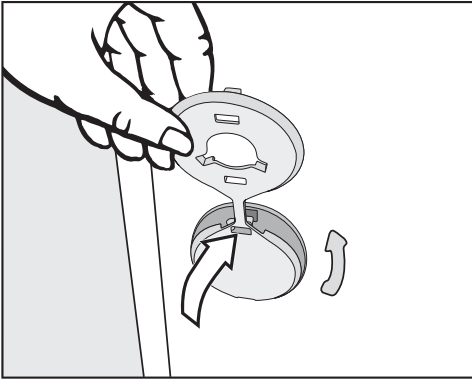

- Plug the holes with the plastic caps as illustrated.

**!** The washer-dryer must not be moved without the transit bars in place.  
Keep the transit bars in a safe place. They must be refitted if the washer-dryer is moved again (e.g. when moving house).

### Re-fitting the transit bars

- Re-fitting is carried out by reversing the procedure.

### Installing under a continuous worktop

**!** The machine lid cannot be removed.

This washer-dryer (with lid intact) can be pushed under a worktop if there is space to do so.

## Aligning the washer-dryer

The washer-dryer must stand perfectly level on all four feet to ensure safe and proper operation.

Incorrect installation may increase electricity and water consumption and may cause the washer-dryer to move about.

## Screwing out and adjusting the feet

The four adjustable screw feet are used to level the washer-dryer. All four feet are screwed in when the machine is delivered.

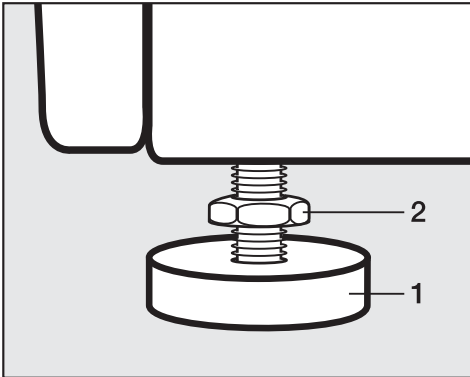

- Using the spanner supplied turn counter nut **2** in a clockwise direction. Then unscrew counter nut **2** together with foot **1**.

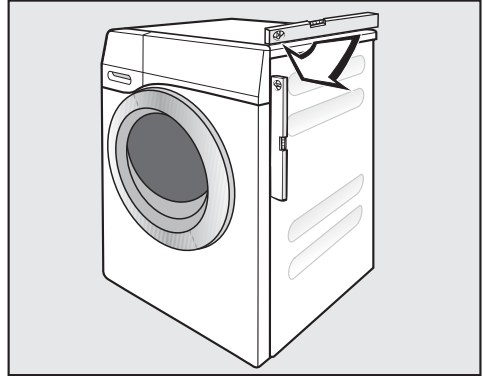

- Use a spirit level to check the washer-dryer is standing level.
- Hold foot **1** securely with a pipe wrench. Turn counter nut **2** again using the spanner supplied until it sits firmly up against the housing.

 All four counter nuts must sit tight up against the casing. Otherwise there is a risk of the machine moving.

Please also check this for the feet which did not need adjustment.

# Installation and connection

---

## The water protection system

The Miele water protection system protects all parts of the washer-dryer from water damage.

The system mainly consists of the following components:

- the inlet hose
- the electronic unit and drainage and overflow protection
- the drain hose

### Inlet hose

- Protects the safety valve from bursting

The inlet hose can withstand pressure greater than 14,000 kPa.

- The inlet hose has a protective sleeve.

The inlet hose has metal braiding as a "second skin" to protect against damage.

## Electronic unit and casing

- Sump

Any leaking water is collected in a sump in the base of the washer-dryer. A float switches off the water inlet valves, preventing any more water from flowing into the machine and water in the suds container is pumped away.

- Overflow protection

This prevents the washer-dryer taking in too much water. If the water level exceeds a certain level, the drain pump switches in and pumps the excess water away in a controlled way.

### Drain hose

The drain hose is protected by a ventilation system which prevents the washer-dryer from being emptied completely.

## Connection to the water supply

The washer-dryer should be connected to the mains water supply in accordance with current local and national safety regulations. The German authorities do not require it to have a non-return valve as the washing machine has been designed to comply with DIN regulations.

The machine is designed to operate with a flow pressure of between 100 and 1000 kPa. If it is higher than 1000 kPa it is essential to fit a pressure reducing valve.

Connection to the mains water supply should incorporate a mains stopcock with 3/4" threaded union. The stopcock should be fitted by a qualified plumber.

 The screw connection is subject to mains water pressure.

Turn on the stopcock slowly and check for leaks. Correct the position of the washer and union if appropriate.

The washer-dryer is **not** suitable for connection to a hot water supply.

## Maintenance

Only use a genuine Miele hose that has been tested to withstand pressure of at least 14,000 kPa should you ever need a replacement.

The dirt filter in the open end of the inlet hose must not be removed.

## Extension hose

A 1.5 metre long (metal) extension hose is available from your Miele dealer or the Miele Spare Parts Department as an optional extra.

# Installation and connection

## Water drainage

The machine drains via a drain pump with a delivery head of 1 metre. The drain hose must not be kinked as this restricts drainage. The swivel elbow at the end of the hose can be turned in either direction, or can be detached if required, with a sharp twist and pull. If required, the drain hose can be extended to a length of 5 m. The necessary parts can be purchased from your Miele Dealer or Miele.

For a delivery head of more than 1 m (up to a max. of 1.8 m) a replacement drain pump will need to be fitted. Please contact Miele or your Miele Dealer for advice. If necessary, the drain hose can be extended to a length of 2.5 m. The necessary parts can be purchased from your Miele Dealer or Miele.

### Drain hose connection:

1. Direct into a sink or basin.

Please note:

- Hook the hose over the edge and secure.
- Make sure that the water can drain away freely without hindrance. Otherwise there is a risk of water overflowing or of some of the drained water being sucked back into the washer-dryer.

2. Connected securely to a plastic drain pipe with a rubber nipple. There is no need to use a non-return valve.

3. Connected securely to a floor gully.

4. Connected securely to a standpipe.

Please note:

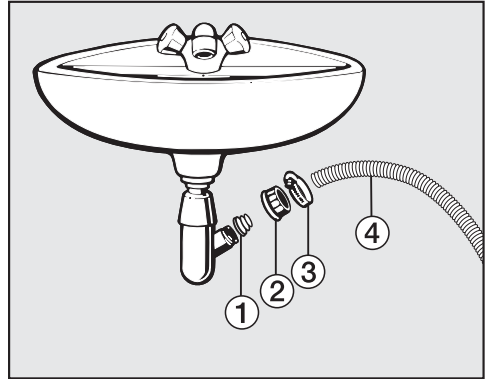

① Adapter

② Nut

③ Hose clip

④ End of the hose

■ Fit adapter ① to the sink drain outlet using nut ②.

■ Attach the end of hose ④ to adapter ①.

■ Use a screwdriver to tighten hose clip ③ up close to the nut.

### Electrical connection U.K.

All electrical work should be carried out by a suitably qualified and competent person, in strict accordance with current national and local safety regulations (BS 7671 in the UK).

Ensure power is not supplied to the appliance until after installation work has been carried out.

The appliance is supplied with a mains cable with moulded plug ready for connection to a 230-240V mains supply.

Please ensure the connection data quoted on the data plate match the household mains supply.

Connection should be made via a suitable switched socket which is easily accessible after installation.

For extra safety it is advisable to protect the machine with a suitable residual current device (RCD). Contact a qualified electrician for advice.

Do not connect via an extension lead. Extension leads do not guarantee the required safety of the appliance (e.g. danger of overheating).

### Non-rewireable plugs BS 1363

The fuse cover must be refitted when changing the fuse, and if the fuse cover is lost, the plug must not be used until a suitable replacement is obtained. The colour of the correct replacement cover is that of the coloured insert in the base of the plug, or the colour that is embossed in words on the base of the plug (as applicable to the design of plug fitted).

Replacement fuses should be ASTA approved to BS 1362 and have the correct rating. Replacement fuses and fuse covers may be purchased from your local electrical supplier.

### **WARNING: THIS APPLIANCE MUST BE EARTHED**

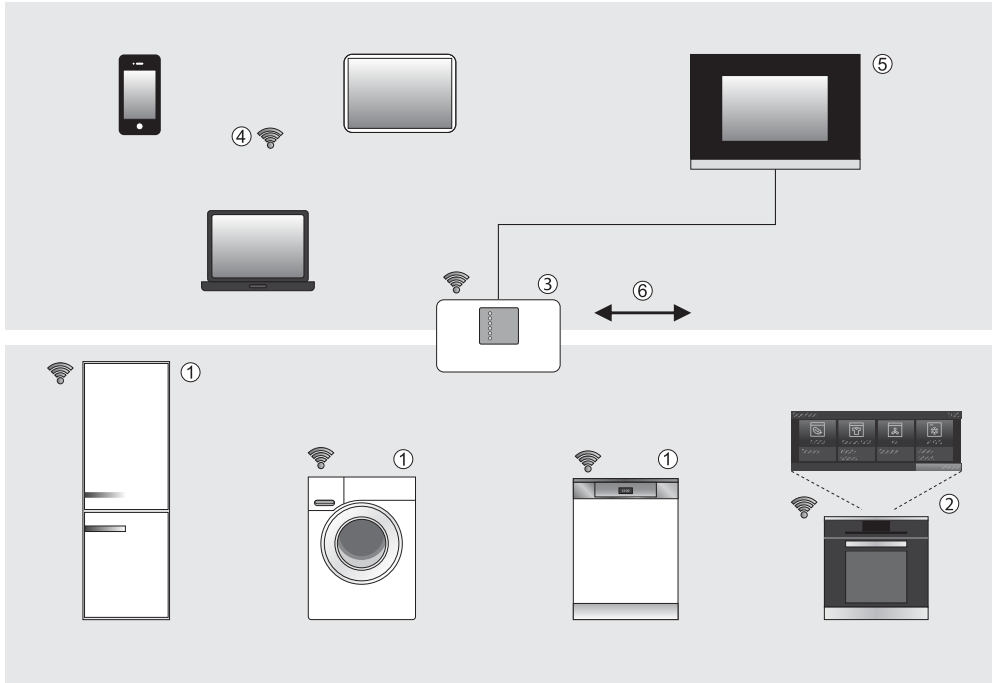

- ① Miele@home communication enabled appliance
- ② Miele@home communication enabled Master appliance with SuperVision functionality
- ③ Wi-Fi Router
- ④ Mobile device (Smartphone, Tablet PC, Notebook)
- ⑤ Connection to a Home automation system
- ⑥ Internet connection



Your household appliance ①/ ② is network enabled.

Your household appliance needs a Wi-Fi module or a Wi-Fi stick (integrated in the appliance, supplied separately or available to order depending on appliance) in order to be connected to your network.

Your household appliance can be connected to the Miele@home system with the assistance of a Wi-Fi router ③ and the Miele@mobile App.

The Miele@home system enables network enabled household appliances to send information to a mobile device ④ or to a master appliance ②, such as an oven with SuperVision functionality, about their operational status, as well as information about the progress of the programme.

## Displaying information and controlling appliances

- Mobile devices ④ with Miele@mobile App  
A Smartphone, Tablet PC or Notebook can be used to display status information about signed on appliances and carry out certain functions. Further ways of using the Miele@mobile App will vary depending on the household appliance.
- SuperVision master appliance ②  
The status of other signed on appliances can be shown in the display of some network enabled appliances.

## Wi-Fi

**Tip:** Make sure that you have sufficient signal strength for your Wi-Fi network where the appliance is installed.

In order to connect an appliance with an integrated Wi-Fi module to your Wi-Fi network you must first activate the network function (see "Settings).

In order to connect an appliance with an external Wi-Fi module or a Wi-Fi stick to your Wi-Fi network you must first install the Wi-Fi module or the Wi-Fi stick (see fitting and installation instructions for your Wi-Fi module or Wi-Fi stick).

## Further information

These accessories are supplied with their own installation and operating instructions.

Further information regarding Miele@home is available on the internet and in the instruction manuals of the various Miele@home components. Please note that the Miele@home and SuperVision system is currently only available in selected countries.

## Miele@mobile App

The Miele@mobile App is available to download free of charge from the Apple App Store® or from the Google Play Store™.



## Connecting the washer-dryer to your WiFi network

Make sure there is sufficient signal strength for your Wi-Fi network where the washer-dryer is installed.

The XKM 3100 W module must be fitted.

There are a number of ways of connecting your washer-dryer to your WiFi network.

### 1. Connect via the Miele@mobile App

The Miele@mobile App can be used to connect to your network.

- Install the Miele@mobile App on your mobile device.
- Follow the instructions in the App as well as the fitting and installation instructions supplied with the XKM 3100 W module.

To log in using the App you will need:

1. Your WiFi network password
2. The password for your washer-dryer

The password for your washer-dryer consists of the last nine digits on the serial number. This can be found on the machine's data plate.

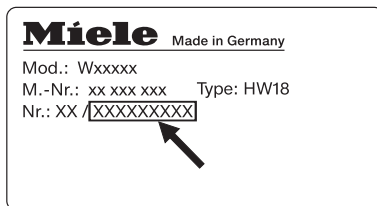

### 2. Connect via WPS

#### Pre-requisites:

- You must have a WPS compatible router.
- The WiFi module must be inserted in the module shaft.
- The washer-dryer must be switched on.

- Follow the fitting and installation instructions supplied with the XKM 3100 W module.

If the connection fails, you have probably not connected WPS to your router quickly enough. Repeat the steps above.

**Tip:** If your WiFi router does not support WPS, please connect via the Miele@home App.

## Technical data

Height	850 mm
Width	596 mm
Depth	637 mm
Depth with door open	1055 mm
Weight	approx. 98 kg
Capacity, washing	7.0 kg dry laundry
Capacity, drying	4.0 kg dry laundry
Voltage	See data plate
Connected load	See data plate
Fuse rating	See data plate
Consumption data	See "Consumption data"
Minimum flow pressure	100 kPa (1 bar)
Maximum flow pressure	1000 kPa (10 bar)
Inlet hose length	1.55 m
Drain hose length	1.50 m
Mains connection cable length	2.00 m
Delivery head max.	1.00 m
Maximum drainage length	5.00 m
LEDs	Class 1
Test certificates awarded	See data plate

# Consumption data

		Load kg	Energy kWh	Water Litres	Duration h:min
<b>Washing</b>					
<b>Cottons</b>	90 °C	7.0	2.10	53	2:29
	60 °C	7.0	1.10	53	2:29
	◁60°C <sup>1)</sup>	7.0	0.93	50	2:59
	◁60°C	3.5	0.75	40	2:59
	40 °C	7.0	0.75	65	2:39
	40 °C	3.5	0.54	47	2:29
	20 °C	7.0	0.35	65	2:39
<b>Minimum iron</b>	30 °C	3.5	0.34	46	1:59
<b>Delicates</b>	30 °C	2.0	0.30	40	1:09
<b>Woollens</b> 	30 °C	2.0	0.23	35	0:38
<b>Automatic</b>	40 °C	5.0	0.78	55	1:57
<b>QuickPower</b>	40 °C	4.0	0.75	45	0:59
<b>Express</b>	40 °C	3.5	0.30	31	0:30
<b>Drying</b>					
<b>Cottons</b>	Normal <sup>2)</sup>	4.0	2.00	17	1:40
<b>Minimum iron</b>	Normal	3.5	1.20	11	1:05
<b>Washing and drying</b>					
<b>Cottons</b>	◁60°C Normal <sup>3)</sup>	7.0 1x 4.0 + 1x 3.0	4.48	90	6:40
<b>QuickPower</b>	40 °C Normal	4.0	3.00	60	2:45

<sup>1)</sup> test programme in acc. with EN 60456

<sup>2)</sup> test programme in acc. with EN 61121

<sup>3)</sup> test programme in acc. with EN 50229

### Note for test institutes

Consumption data and programme durations can vary from the nominal values given depending on water pressure, water hardness, water inlet temperature, room temperature, type and volume of load, residual moisture levels after drying, fluctuations in the electricity supply and any options selected.

With *PowerWash 2.0*, the temperature measured by the sensor in the suds container is higher than the actual temperature of the laundry during the heating phase.

The temperature measured here **does not** reflect the temperature of the laundry.

# Settings

The settings are used to alter the washer-dryer's electronics to suit different requirements. Settings can be altered at any time.

## To access Settings

Before you begin, ensure that:

- The washer-dryer is switched on.
- The standard display is showing.

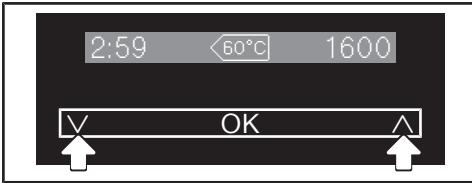

- Touch the V and ^ sensors at the same time.

The following will appear in the display:



You are now in the Settings menu.

## Selecting a setting

- Touch the V or ^ sensor until the setting you want appears in the display.
  - The V sensor scrolls down the list.
  - The ^ sensor scrolls up the list.
- Touch the OK sensor to select the setting displayed.

## Changing a setting

- Touching the V sensor will call up the different options for the setting.

The option which is selected will have a tick ✓ next to it.

- When the option you want shows in the display touch the OK sensor to activate it.

## To exit Settings

- Touch the V or ^ sensor repeatedly until Back ← appears in the display.
- Touch the OK sensor.

## Language

The display can be set to appear in one of several different languages.

The flag  after the word *Language* acts as a guide to prevent a language which will not be understood from being set.

The selected language will be stored in memory.

## Degree of soiling

You can select the default setting for the degree of soiling or switch off the degree of soiling query.

### Options

- Default setting  
You can choose between the Light, Normal or Heavy degree of soiling settings.  
Factory default setting: Normal
- Query  
You can switch the degree of soiling query on or off.  
Factory default setting: On

## Buzzer volume

You can select one of seven different settings for the buzzer volume.

The settings are represented by a bar chart. At the lowest setting, the buzzer is switched off.

## Keypad tone

Each touch of a sensor or press of a button is confirmed with an audible tone.

Factory default setting: the keypad tone is switched on.

## Code

The code prevents the washer-dryer being used without your knowledge.

### Options

- Activate  
The code is 125 and can be activated.  
When the code has been activated, you have to enter the code after switching the washer-dryer on. Otherwise the washer-dryer cannot be operated.
- Deactivate  
For using the washer-dryer without entering the code. This only appears if the code has been activated previously.
- Change  
You can enter a code of your own.

If you forget the code the machine will have to be unlocked by Miele Service.

Make a note of the new code.

# Settings

---

## Temperature unit

The temperature can be displayed as degrees Celsius (°C) or Fahrenheit (°F).

Factory default setting: Celsius (°C).

## Display brightness

There are seven different display brightness settings.

The brightness changes as soon as you select a different setting.

## Dark display

To save energy, the display will go out and the *Start/Stop* button will flash slowly.

### Options

- On  
The display will go out after 10 minutes.
- On (not in current programme) (Factory default setting)  
The display will remain on while the programme is running but will go out 10 minutes after the end of the programme.
- Off  
The display will remain on.

## Machine switch-off

The washer-dryer will switch off automatically after the end of the programme/anti-crease phase or after being switched on if no further selection is made.

### Options

- After 15 minutes (Factory default setting)  
The washer-dryer will switch itself off after 15 minutes.
- After 20 minutes  
The washer-dryer will switch itself off after 20 minutes.
- After 30 minutes  
The washer-dryer will switch itself off after 30 minutes.

## Display maximum load

After a programme is selected the maximum load appears in the display for a short time. You can switch this off.

Factory default setting: *Display maximum load* is switched on.

## Display programme name

The name of the selected programme is shown briefly in the display.

The factory default setting for *Display programme name* is switched off.



## Memory

The washer-dryer will save the last settings selected for a programme (temperature, spin speed and some of the options) after the programme has started.

The next time that programme is used those settings will appear in the display.

Factory default setting: Memory function switched off.

## Pre-wash Cottons

If you require a longer pre-wash you can extend the Cottons programme's standard pre-wash time of 25 minutes

### Options

- Normal (Factory default setting)  
25 minute pre-wash.
- +6 minutes  
31 minute pre-wash.
- +9 minutes  
34 minute pre-wash.
- +12 minutes  
37 minute pre-wash.

## Soak duration

You can set a duration for the soak process of between 30 minutes and 5 hours.

You can select the duration in 30 minute increments. When the *Soak* option is selected the laundry will be soaked for the duration selected.

## Gentle action

Activating gentle action reduces the drum action and is suitable for washing lightly soiled items more gently.

Gentle action can be activated for the *Cottons* and *Minimum iron* programmes.

If Gentle action is activated, each wash phase in the programme selected will be run with the Gentle action wash rhythm.

Factory default setting: Gentle action is switched off.

# Settings

---

## Temperature reduction

The boiling point for water is lower at high altitudes. In order to avoid water boiling, Miele recommend activating the reduce temperature setting at altitudes of more than 2000 m above sea level. The maximum temperature is reduced to 80°C even when a higher temperature is selected.

Factory default setting: the temperature reduction setting is switched off.

## Water plus

You can increase the amount of water used in the wash programmes.

### Options

- Water plus (factory default)  
More water is used in the wash and rinse stages.
- Extra rinse  
An additional rinse is carried out.
- Water plus and Extra rinse  
The water level is increased in the wash and rinse stages and an extra rinse is carried out.

## Water plus level

There are four different water levels which can be selected with Water plus.

### Level

- Normal (Factory default setting)
- Plus ∆
- Plus ∆∆
- Plus ∆∆∆

## Maximum rinse level

The water level in the rinse cycle can be permanently set to the highest value.

This function is useful for allergy sufferers as it achieves an excellent rinse result. Water consumption will increase.

Factory default setting: the maximum rinse level setting is switched off.

## Suds cooling

When this is activated, additional water flows into the drum at the end of the main wash to cool the suds down. Hot suds can damage plastic drainage pipes.

Suds cooling takes place when a temperature of 70 °C or higher is selected for the Cottons programme.

Suds cooling should be activated:

- to prevent the danger of scalding if the drain hose is hooked over the edge of a sink or basin.
- where drainage pipes do not comply with DIN 1986.

Factory default setting: Suds cooling is switched off.

## Low water pressure

If the water pressure is below 100 kPa the washer-dryer will stop the programme and an error message will appear in the display.

This setting can be activated to ensure problem free water intake where the water pressure is constantly low (below 100 kPa).

Factory default setting: *Low water pressure* is switched off.

## Distribution controller

The maximum final spin speed can be limited to prevent laundry forming a ring around the drum. This setting is only effective when washing and drying in a continuous sequence.

### Options

- 1200 rpm (factory setting)
- 1100 rpm
- 1000 rpm
- 900 rpm

## Drying levels

You can adjust the drying levels in the *Cottons*, *Minimum iron* and *Automatic* programmes.

The drying level is shown in a bar chart:

- Less bars = damper
- More bars = drier

# Settings

---

In order to see the following settings you need a WiFi module (see optional accessories).

## Miele@home

The Miele@home setting is only visible when the WiFi module is fitted.

### Module settings

We recommend connecting the washer-dryer to your WiFi network via the Miele@mobile App or WPS. If you would rather set up the connection to your router yourself, or you have a special network configuration, you can enter the relevant settings yourself as long as you have the necessary technical knowledge.

#### Module-Info

Displays information via the WiFi module.

#### Start module activity

If you wish to reset all entered settings and values for Miele@home, you can restore the factory default settings on your WiFi module. Any settings, which do not affect Miele@home will remain unchanged.

Select **Restart with default** and confirm with **OK**.

### System settings

You can sign the washer-dryer into an existing Miele@home network and sign it off under this option. Precise instructions for doing so are given in the Miele@home instruction manual.

## Remote control

The Remote control setting is only visible when the WiFi module is fitted and signed on.

Once the Miele@mobile App has been installed on your mobile device, you can check the status of your washer-dryer from anywhere and start it remotely.

The Remote control setting has to be switched on if you want to start your washer-dryer with your mobile device.

If Remote control is not switched on the App can cause the programme to be cancelled.

Use the "Delay start" button to set a time frame in which you want the washer-dryer to start and start the delay period (see "Delay start").

The washer-dryer will then start during this period once it has received a signal from you.

If it has not received a signal from you by the latest start time set, the washer-dryer will start automatically.

Remote control is switched off by default.

## SmartGrid

The SmartGrid setting is only visible when the WiFi module is fitted and signed on.

This function can be used for starting your washer-dryer automatically at a time when your energy costs are most economical.

Activating SmartGrid, gives the *Delay start* button a new function.

Set SmartStart with the "Delay start" button.

The washer-dryer will then start within the timeframe that you have specified when it receives a signal from your energy supplier.

If it has not received a signal from your energy supplier by the latest start time set, the washer-dryer will start automatically.

The *SmartGrid* function is switched off by default.

## SmartStart

If you have activated the SmartGrid function in Settings, instead of Start in, SmartStart will appear in the display when you press the Delay start button.

You can define a period (from 15 minutes to 24 hours), in which the wash programme must be started. The procedure for setting this is the same as for setting the time for Delay start.

## Optional accessories

---

Detergent, fabric care, additives and machine care products are available for this washing machine. All the products have been designed for Miele washing machines.

These and many other useful products can be ordered via the internet at [www.miele-shop.com](http://www.miele-shop.com) or from Miele (see end of this booklet for contact details).



### Detergent

#### UltraWhite

- powder detergent
- suitable for white and light coloured laundry as well as heavily soiled cotton items
- effective stain removal even at low temperatures

#### UltraColor

- liquid detergent for coloureds
- suitable for coloured and dark/black garments
- protects bright colours from fading
- effective stain removal even at low temperatures

### Wool and delicates detergent

- liquid detergent for delicates
- particularly suitable for woollen and silk garments
- cleans at temperatures as low as 20 °C, helps retain the shape of delicate garments and protect colours

### Specialist detergents

Specialist detergents are available as capsules  in convenient single dose amounts or in a handy bottle.

### Outdoor

- liquid detergent for outerwear and performance clothing
- cleans with care and is gentle on colours
- with lanolin to care for and condition membrane fabric

### Sport

- liquid detergent for sportswear and fleece garments
- neutralises unpleasant odours
- retains the shape of the textiles

### Down items

- liquid detergent suitable for pillows, sleeping bags and down filled items
- retains the elasticity of down and feather filled items
- retains the breathability of down filled items
- prevents down filling clumping together

### WoolCare

- liquid detergent for woollens and delicates
- with a special wheat protein conditioning formula
- helps prevent pilling
- gentle on colours
- only available as capsules 

### SilkCare

- liquid detergent for silks
- with a special silk protein conditioning formula
- gentle on colours
- only available as capsules 

### Fabric care

Fabric care agents are available as capsules  in convenient single dose amounts or in a handy bottle.

### Proofing agent

- for reproofing microfibre garments e.g. rain coats etc.
- retains the breathability of garments

### Fabric conditioner

- fresh, natural fragrance
- makes laundry soft to handle

### Additives

#### Booster

- for removing stains
- suitable for white and coloured laundry
- available as capsules  in convenient single dose amounts

### Machine care products

#### Machine cleaner

- for cleaning the washing machine thoroughly and effectively
- removes grease, bacteria and unpleasant odours

#### Descaling agent

- removes heavy limescale deposits
- mild and gentle with natural citric acid









## United Kingdom

Miele Co. Ltd.  
Fairacres, Marcham Road  
Abingdon, Oxon, OX14 1TW  
Customer Contact Centre Tel: 0330 160 6600  
E-mail: mielecare@miele.co.uk  
Internet: www.miele.co.uk

## Australia

Miele Australia Pty. Ltd.  
ACN 005 635 398  
ABN 96 005 635 398  
1 Gilbert Park Drive, Knoxfield, VIC 3180  
Tel: 1300 464 353  
Internet: www.miele.com.au

## China

Miele (Shanghai) Trading Ltd.  
1-3 Floor, No. 82 Shi Men Yi Road  
Jing' an District  
200040 Shanghai, PRC  
Tel: +86 21 6157 3500, Fax: +86 21 6157 3511  
E-mail: info@miele.cn, Internet: www.miele.cn

## Miele (Hong Kong) Limited

41/F - 4101, Manhattan Place  
23 Wang Tai Road  
Kowloon Bay, Hong Kong  
Tel: (852) 2610 1025, Fax: (852) 3579 1404  
Email: customerservices@miele.com.hk  
Website: www.miele.hk

## India

Miele India Pvt. Ltd.  
Ground Floor, Copia Corporate Suites  
Plot No. 9, Jasola, New Delhi - 110025  
Tel: 011-46 900 000, Fax: 011-46 900 001  
E-mail: customercare@miele.in, Internet: www.miele.in

## Ireland

Miele Ireland Ltd.  
2024 Bianconi Avenue  
Citywest Business Campus, Dublin 24  
Tel: (01) 461 07 10, Fax: (01) 461 07 97  
E-Mail: info@miele.ie, Internet: www.miele.ie

## Manufacturer: Miele & Cie. KG

Carl-Miele-Straße 29, 33332 Gütersloh, Germany

# Miele

## Malaysia

Miele Sdn Bhd  
Suite 12-2, Level 12  
Menara Sapura Kencana Petroleum  
Solaris Dutamas No. 1, Jalan Dutamas 1  
50480 Kuala Lumpur, Malaysia  
Phone: +603-6209-0288  
Fax: +603-6205-3768

## New Zealand

Miele New Zealand Limited  
IRD 98 463 631  
Level 2, 10 College Hill  
Freemans Bay, Auckland 1011, NZ  
Tel: 0800 464 353  
Internet: www.miele.co.nz

## Singapore

Miele Pte. Ltd.  
163 Penang Road  
# 04 - 03 Winsland House II  
Singapore 238463  
Tel: +65 6735 1191, Fax: +65 6735 1161  
E-Mail: info@miele.com.sg  
Internet: www.miele.sg

## South Africa

Miele (Pty) Ltd  
63 Peter Place, Bryanston 2194  
P.O. Box 69434, Bryanston 2021  
Tel: (011) 875 9000, Fax: (011) 875 9035  
E-mail: info@miele.co.za  
Internet: www.miele.co.za

## United Arab Emirates

Miele Appliances Ltd.  
Gold & Diamond Park  
Office No. 217-6, Sheikh Zayed Road  
P.O. Box 11 47 82 - Dubai  
Tel. +971 4 3044 999  
Fax. +971 4 3418 852  
800-MIELE (643563)  
E-Mail: info@miele.ae  
Website: www.miele.ae

WTF 130 WPM



en-GB

M.-Nr. 10 506 500 / 03