



WD60CONX/12

WD60PROX/12

Contents

Appliance Description	8
Main Components	8
How the warming drawer works.....	8
Use	9
Before using for the first time.....	9
Control Panel.....	9
Using the warming drawer	9
Selecting the function	9
Cleaning and Maintenance	11
Appliance front and control panel	11
Interior of the warming drawer	11
Mat with non-slip surface	11
What should I do if the warming drawer doesn't work?	12
Installation	13
Combination possibilities	13

We ask you to read the instructions in this booklet very carefully as this will allow you to get the best results from using your warming drawer.

KEEP THE DOCUMENTATION OF THIS PRODUCT FOR FUTURE REFERENCE.

ATTENTION!

To benefit from our guarantee you must send off the warranty card and, when requesting a service engineer call out, you must present the warming drawer receipt, stamped and dated by the shop where you bought the appliance. Failure to do this may lead to your warranty being invalid.

Safety Instructions



- **Warning!** Before connecting the appliance compare the power data (voltage and frequency) indicated on the characteristics plate with those of the power supply in question. If these data do not match there may be problems. In case of doubt, contact an electrician.
- **Warning!** If the electrical wire plug is removed, the appliance must be installed and connected by a technician. Contact a qualified electrician who knows and respects current safety standards. The manufacturer cannot be held responsible for damage resulting from fitting or connecting errors.
- **Warning!** The electrical safety of the appliance can only be guaranteed if it is earthed. The manufacturer cannot be held responsible for damage resulting from the absence of or defects in the installation's protection system (e.g. electrical shock).
- **Warning!** Only use the appliance once it has been fitted into its built-in position. Only in this manner can it be guaranteed that users cannot access the electrical components.
- **Warning!** Never open up the appliance's frame. Possible contacts with electrical conducting parts or changes to electrical or mechanical components may represent a danger to users' safety and prejudice the correct working of the appliance.
- **Warning!** Repairs and maintenance, especially of parts carrying electrical current, must only be done by technicians authorised by the manufacturer. **The manufacturer and retailers do not accept responsibility** for any damaged caused to people, animals or property as a result of repairs and maintenance carried out by non-authorized personnel.
- **Warning!** Repairs undertaken during the guarantee period must only be done by technicians authorised by the manufacturer. If this is not the case then any damage resulting from the repair in question is excluded from the guarantee.
- **Warning!** The appliance must be disconnected from the electrical current when installation and repair work is being done. To disconnect the appliance from the current, one of the following conditions must apply:
 - The switchboard fuses / circuit breakers must be disconnected.
 - The plug should be removed from the socket. To remove the plug from the socket do not pull on the electric cable but rather pull out the plug itself directly.

Safety Instructions

- This appliance complies with current safety standards. Improper use of the appliance may put the user at risk.
- Read the operating instructions carefully before using the appliance for the first time. In this way you will avoid the risk of injuring yourself or damaging the appliance.
- The warming drawer is solely for domestic use!
- Use the warming drawer solely for warming crockery. Any other type of use is unacceptable and may be dangerous. The manufacturer does not accept responsibility for breakdowns or faults arising from improper or erroneous use of the appliance.
- Do not use the appliance to heat up or to cook food or drinks.
- Depending on the temperature selected and the operating time, the temperature inside the appliance may reach 80 °C. To take crockery out of the warming drawer protect your hands by using oven gloves or an oven cloth.
- Take special care with children and do not allow them to play close to the appliance. If the appliance is inadvertently switched on it will heat up and may cause serious burns.
- **WARNING: The appliance and its accessible parts become hot during use.**
Care should be taken to avoid touching heating elements. Children less than 8 years of age shall be kept away unless continuously supervised.
- **This appliance can be used by children aged from 8 years and above and persons with reduced physical, sensory or mental capabilities or lack of experience and knowledge if they have been given supervision or instruction concerning use of the appliance in a safe way and understand the hazards involved. Children shall not play with the appliance. Cleaning and user maintenance shall not be made by children without supervision.**

Precautions during use

- Do not sit or hang on the drawer. The telescopic runners will be damaged. The maximum load capacity of the drawer is 25 kg.
- Do not store synthetic containers or easily inflammable objects inside the warming drawer. When you switch on the appliance such containers and objects may melt or catch fire.
Fire danger.
- Do not use the appliance to heat up the air temperature in the kitchen. The high temperatures reached may cause easily inflammable objects close to the appliance to catch fire.
- Do not use high pressure or steam jet cleaning devices. The steam may affect electrical components and cause a short circuit. The steam pressure may also cause damage to the appliance's surface and components in the long term.
- When you stop using the appliance at the end of its working life, disconnect it from the power supply and render the electrical cable unusable so that the appliance is not a danger if, for example, children use it for playing.

Installation instructions

Before installation

Check that the input voltage indicated on the characteristics plate is the same as the voltage of the power outlet you are going to use.

Open the drawer and **take out all the accessories** and remove the packing material.

Attention! The front surface of the crockery heater may be wrapped in a **protective film**. Before using the warming drawer for the first time, remove this film carefully.

Make sure that the warming drawer is not damaged in any way. Check that the drawer opens and closes correctly. If you find any damage, contact the Technical Assistance Service.

Attention: the power socket should be easily accessible after the warming drawer has been installed.

The warming drawer should only be built-in in combination with those appliances indicated by the manufacturer. **If it is fitted in combination with other appliances, the guarantee is no longer valid since it is impossible to guarantee that the warming drawer will work correctly.**

Installation

To build-in the warming drawer in combination with another appliance there must be a fixed, interim shelf in the housing unit to support the weight of both appliances.

The appliance to be combined with the warming drawer will be placed directly on the latter without any need to have a separating shelf.

To build-in the appliance which is combined with the warming drawer, follow the instructions set out in the respective instructions and fitting booklet.

The relevant installation dimensions are indicated in mm **in the diagrams shown at the end of this booklet.** Proceed as follows:

1. Place the warming drawer on the shelf and slide it towards the interior of the niche in such a way that it is centred and completely lined up with the front of the unit.
2. Check that the warming drawer's frame is properly levelled and is sitting evenly on the shelf.
3. Open the drawer and fix the warming drawer to the sides of the unit using the two screws provided.

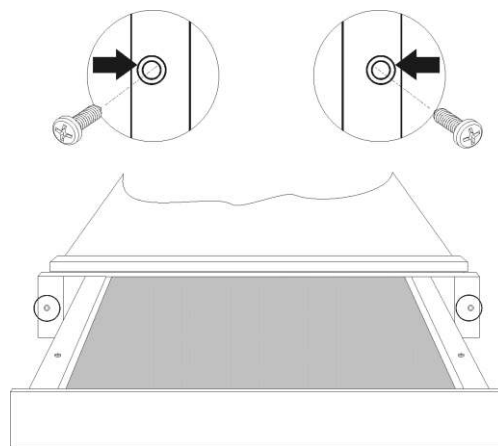

Electrical Connection

The warming drawer is equipped with a power cable and plug for single phase current. We advise that the **plug is connected to a socket that is easily accessible after installation.**

If the warming drawer is to be installed on a permanent basis it should be installed by a qualified technician. In such a case, the appliance should be connected to a circuit with an all-pole circuit breaker with a minimum separation of 3 mm between contacts.

The data necessary for the electrical connection are **described on the warming drawer's characteristics plate** and these must be compatible with those of the power outlet you are going to use.

WARNING: THE WARMING DRAWER MUST BE CONNECTED TO EARTH.

The manufacturer and retailers do not accept responsibility for any damage that may be caused to people, animals or property if these installation instructions are not observed.

1. Place the warming drawer on the shelf and slide it towards the interior of the niche in such a way that it is centred and completely lined up with the front of the unit.

Appliance Description

Main Components

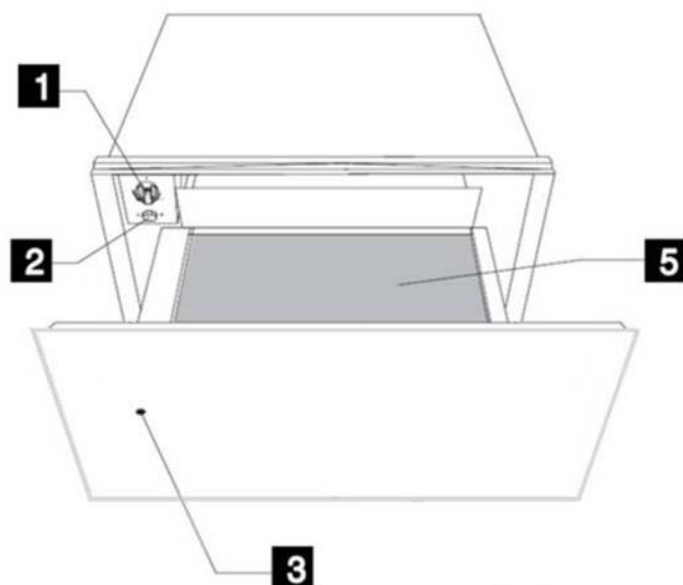

- 1** Function selector
- 2** On/Off switch

- 3** Control Lamp
- 5** Anti-Slip mat

How the warming drawer works

This appliance is equipped with a warm air circulation system. A fan distributes the heat generated by an electrical heating element throughout the interior of the appliance.

The thermostat allows the user to define and control the temperature wanted for the crockery.

The circulating hot air that is generated heats up the crockery quickly and evenly.

A metal grille protects both the heating element and the fan.

The base of the drawer is fitted with a non-slip mat to prevent plates and dishes sliding around when the drawer is opened and closed.

Use

Before using for the first time

Before using the appliance for the first time you should clean the interior and the exterior, following the cleaning instructions given in the section "Cleaning and Maintenance".

Then heat the warming drawer for at least 2 hours. For this, turn the temperature control to the maximum position (see section "Selecting temperature").

Make sure the kitchen is well-ventilated when you are doing this.

The appliance's parts are protected by a special product. For this reason, during the first heating an odour will be released. Both the odour and any smoke that may form will disappear after a short time and neither signifies that there is anything wrong with the connection or the appliance.

Control Panel

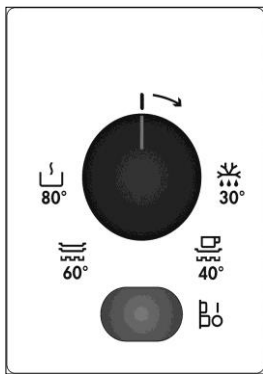

The control panel has a temperature selector and the on/off switch. The control panel is only visible when the drawer is open.

When the drawer is closed you can check whether the warming drawer is switched on by looking through the viewing port on the front of the appliance.

Using the warming drawer

To use the warming drawer, proceed as follows:

- Put the crockery in the drawer.
- Select the temperature you want by turning the thermostat control to the desired position.
- Switch on the appliance by pressing the switch, which will light up.
- Close the drawer.

Be careful not to use too much force when closing the drawer since it may open up again.

Before taking out the warm crockery you must switch off the warming drawer by pressing the switch again.





Selecting the function

By turning the thermostat control you can select temperatures between 30 and 80 °C.

Do not force the thermostat control to the left of the "0" position or to the right of the maximum position since this may damage the appliance.

As soon as the temperature selected is reached, the heating is turned off. When the temperature drops to a value below that selected, the heating is turned back on.

The temperature scale is not marked with absolute temperatures in °C but instead has symbols which correspond to the optimum temperatures for groups of crockery:

Symbol	°C	Function
	30°C	Defrosting
	40°C- 50°C	Proving dough Cups / glasses warming
	60°C- 70°C	Crockery warming Keep food warm
	80°C	Low temperature cooking Food Warming

Selecting function**Heating times**

Various factors affect heating times:

- Material and thickness of the crockery;
- Load quantity;
- How the crockery is arranged;
- Temperature setting.

It is therefore not possible to give any precise heating times.

However, as a guide, the following times are given for the thermostat setting  and for uniform heating of the crockery:

Load	Time (min)
Crockery for 6 people	30 – 35

As you use the warming drawer more and more you will learn the best settings for your crockery.

Suggestions for the function Keep Food Warm and Food Warming:

Preheat the Warming Drawer 15 minutes to ensure the interior space has the required temperature.

Load capacity

Load capacity depends on the size of the items of crockery. The crockery warmer can be loaded with a maximum of 25 kg.

Below we give you some crockery arrangements as examples:

- Crockery for 6 people:
 - 6 dinner plates Ø 28 cm
 - 6 soup bowls Ø 10cm
 - 1 dish Ø 22 cm
 - 1 dish Ø 19 cm
 - 1 dish Ø 17 cm
 - 2 large plates Ø 36 cm

or one of the following

- 20 dinner plates Ø 28 cm
- 36 soup bowls Ø 22 cm
- 30 soup bowls Ø 10cm
- 10 dinner plates Ø 28cm
- 10 soup bowls Ø 22 cm
- 10 pizza plates Ø 36 cm
- 80 espresso cups
- 40 cappuccino cups
- 30 glasses
- 18 soup bowls Ø 22 cm; 2 soup tureens 21 cm x 18 cm
- Etc.

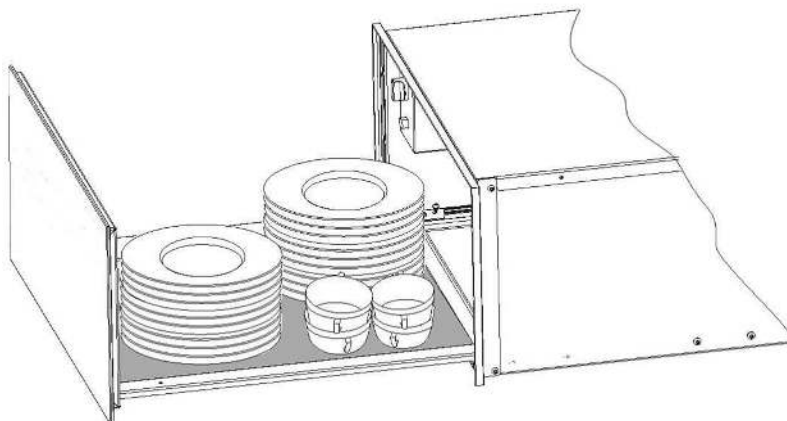

Cleaning and Maintenance

Cleaning is the only maintenance action that is required normally.

Warning! Cleaning must be done with the warming drawer disconnected from the electrical power supply. Remove the plug from the power socket or disconnect the warming drawer power supply circuit.

Do not use aggressive or abrasive cleaning products, abrasive sponges or pointed objects since stains or abrasion marks may appear.

Do not use high pressure or steam jet cleaning appliances.

Appliance front and control panel

The warming drawer can be cleaned using just a damp cloth. If it is very dirty, add a few drops of washing-up liquid to the washing water.

Wipe the surfaces dry using a dry cloth.

For stainless steel fronted warming drawers, special products for treatment of stainless steel surfaces can be used. These products prevent the surfaces becoming dirty again for some time. Apply a thin layer of such a product on the surface using a soft cloth.

On aluminium fronted warming drawers use a gentle glass cleaning product and a soft cloth that does not release fluff. Wipe horizontally without pressing on the surface since aluminium is sensitive to scratches and cuts.

Interior of the warming drawer

Clean the inside of the warming drawer regularly using a damp cloth. If it is very dirty add a few drops of washing-up liquid to the washing water.

Wipe the surfaces dry using a dry cloth.

Avoid water entering through the air circulation opening.

Only use the warming drawer again when it is completely dry.

Mat with non-slip surface

The non-slip surface mat can be removed to facilitate cleaning of the drawer.

The mat can be cleaned by hand using hot water with a few drops of washing-up liquid.

Dry thoroughly.

The non-slip mat should only be replaced when it is completely dry.

What should I do if the warming drawer doesn't work?

WARNING! Any type of repair must only be done by a specialised technician. Any repair done by a person not authorised by the manufacturer is dangerous.

Before contacting Technical Assistance, check on the following:

- **The crockery doesn't heat up enough.**
Check whether:
 - The appliance has been switched on.
 - The appropriate temperature has been selected.
 - The air circulation orifices are covered by the crockery.
 - The crockery was left to heat up for sufficient time.

Heating time depends on several factors, such as, for example:

- Crockery material type and thickness.
- Quantity of crockery.
- How the crockery is arranged.

- **The crockery doesn't heat up at all.** Check whether:
 - You can hear the noise of a fan.
If the fan is operating then the heating element is broken; if the fan is not operating then the fan is broken.
 - The switchboard fuses / circuit breakers have fused / tripped out.
- **The crockery is heating up too much.**
 - The temperature selector is broken.
- **The on/off switch does not light up.**
 - The switch's pilot light has blown.

Installation

Combination possibilities

WD60CONX/12

WD60PROX/12

